

Performance Evaluation of On-Grid and Off-Grid Solar Photovoltaic Systems

Ajan.A¹, Nirmala John²

Student, Electrical and Electronics Engineering, Christ University, Bangalore, India¹

HOD, Electrical and Electronics Engineering, Christ University, Bangalore, India²

Abstract: The demand for electrical energy is peaking. At the same time the conventional energy sources are depleting. In order to bridge the gap between the increasing demand and production some alternative energy resources have to be exploited. Renewable energy resources seem to be a promising solution. Solar energy having its own importance in such a scenario as it is clean, environmental friendly and infinite source of energy. The solar photo voltaic systems can be classified in to off-grid and on-grid systems. The yield of a solar photovoltaic system depends on various factors such as irradiation, temperature. Evaluation of the existing system is very important for the characterization of the existing problems and for the future improvements. For the evaluation a MATLAB/SIMULINK model is prepared for an on-grid and off-grid photovoltaic system. This study aims the evaluation of various power and voltage levels, charging and discharging trends of the battery bank, and the amount of power injected to the grid.

Keywords: Matlab, Simulink, On-grid systems, off-grid systems, performance evaluation

I. INTRODUCTION

Many renewable energy sources such as solar, tidal and wind is being exploited for the energy generation as they are clean and infinite source of energy. The yield of a solar PV system is depends upon many factors like the irradiation and temperature. But the overall system efficiency is a function of the performance of various components in the system such as array, MPPT, converter, storage device and the inverter. [1] Explains how the atmospheric conditions affecting the output of a system. For evaluating the PV system topologies some guidelines have to be followed [2]. Every system should study based on some generalized parameters [3]. But the solar and wind energy sources are intermittent in nature. Grid connected energy storage is a solution for the problems occurring due to the intermittencies [4],[5]-[7] Explains about the development of a solar photo voltaic system in simulink. The major difference between a standalone and a grid tied system is the energy storage. Standalone system stores the surplus energy in the storage system while the grid tied system injects the energy produced to the grid. This paper is divided in to two parts. The first part includes the modelling of various components and the second part consisting of the simulation results.

II. MODELLING OF COMPONENTS

For the simulation of the system modelling of each component is necessary.

A. Modelling of a Photo Voltaic Module

Solar cell is made up of a p-n junction .When the cell is exposed to solar radiation electron hole pair is generated. The generated electron hole pair will experience a drift in the internal electric field. If the cell is connected to an external circuit the electrons will flow through that external circuit. The voltage across the cell when it is open circuited is called open circuit voltage V_{oc} the current flowing through the cell when it is short circuited is called

short circuit current I_{sc} . The equations mentioned below are used for the modelling of a photovoltaic system [8]-[9].

$$V_t = \frac{K_{top}}{q}$$

$$I_{rs} = \frac{I_{sc}}{e^{\frac{K_{top}}{q} - n}} - 1$$

$$I_{sh} = \frac{V + I_{rs}}{R_p}$$

$$I_d = \left[e^{\frac{(V + I_{rs})}{N V_t C N_s}} - 1 \right] I_s N_p$$

$$I = I_{ph} N_p - I_d - I_{sh}$$

$$V_{oc} = V_t \ln \left(\frac{I_{ph}}{I_s} \right)$$

$$I_{ph} = G_k [I_{sc} + K_1 (T_{op} - T_{ref})]$$

Where

G_k =Solar irradiance ratio

V_t =Thermal voltage

K =Boltzmann's constant $1.38e-23$

T_{op} =Operating temperature in Celsius

T_{ref} = Reference temperature $25^\circ C$

q =Charge of an electron $1.6e-19 C$

I_s =Diode reverse saturation current, A

I_{rs} =Diode reverse saturation current

I =Output current from the module, A

I_{sh} =Shunt current, A

V =Output voltage from the module, V

N =Diode ideality factor

C =Number of cells in a module

N_s =Number of modules in series

E_g =Energy gap of silicon, 1.12eV
 N_p =Number of modules in parallel

B. Modelling of MPPT

MPPT is used to track the maximum power point during the varying climatic conditions. MPPT acts as a variable load across the photovoltaic system [10]. There are various MPPT algorithms are available such as constant voltage, incremental conductance method, perturb and observe method etc. Among these the simplest one is perturb and observe method.

C. Modelling of a DC-DC converter

DC-DC converters are used convert the DC voltage levels. Various topologies are available such as buck, boost, buck boost and CUK are available [11]. In the modelled system a boost converter is used to boost up the voltage during the operation to felicitate the battery charging.

D. Modelling of a Regulator

A regulator is necessary to regulate the fluctuating voltage during the varying climatic condition. CUK converter is an efficient converter along with a PID controller in feedback is a promising solution for this.

E. Modelling of a Battery Bank

A 48 V 500 Ah battery bank is modelled using the manufactures data sheet. The battery model exist in the simulink block library is configured using the data sheet. The characteristics of the simulated battery model are shown in the Fig 1.

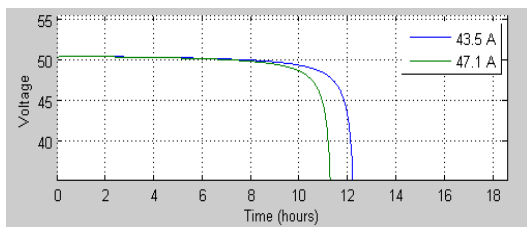

Fig.1 Performance characteristics of the simulated battery model

F. Phase Locked Loop

Phase Locked Loops are used in the simulation model of grid tied solar PV system. PLL is used to synchronize the injected solar power with the grid. The following block diagram explains the working of a PLL. Phase Locked Loops basically consists of a phase detector and a Voltage Control Oscillator. The phase detector measures the phase

of the input signal and compares with a reference signal. The error is used to drive the VCO. The VCO outputs a signal which is feedback to the input of the system through an optional divider. If any drift in the phase remains the error generated will be higher which will produce an out of phase signal from the VCO.

G. Inverter With Current Control

Inverters are used to convert the DC power produced by the PV modules to AC. The performance of the inverters

depends upon the control strategy which is used to generate the gate pulse. Commonly current control methods are used. In the simulation model of the grid tied solar PV systems the PLL will synchronize the power injected by the PV system and along with that PLL produces a reference current for the control of the inverter. The inverter current and the current reference given by the PLL compared each other and a switching signal is produced for the current control of the inverter.

H. Models of Standalone and Grid tied System

The simulation models prepared in the MATLAB is given below. Fig 2 and Fig 3 represents the simulation models of standalone and grid tied system.

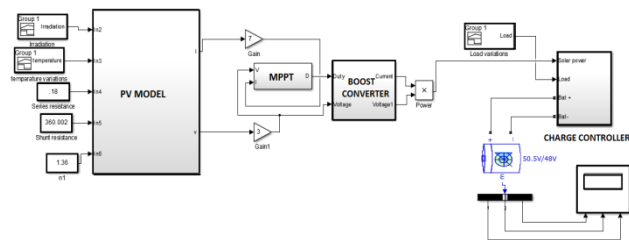

Fig 2. Model of a standalone system

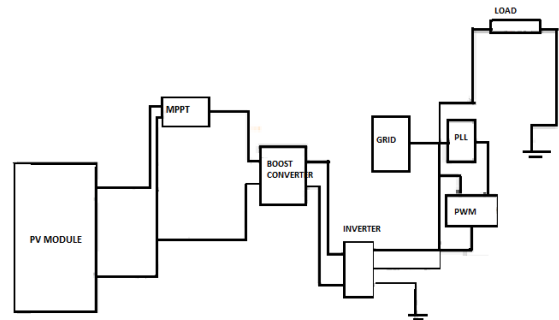

Fig 3 Model of a grid-tied system

III.RESULTS AND DISCUSSIONS

The simulated results are shown below.

A. Dependence of various parameters on the power output

Fig 4 shows the variation of power according to the variation in irradiation.

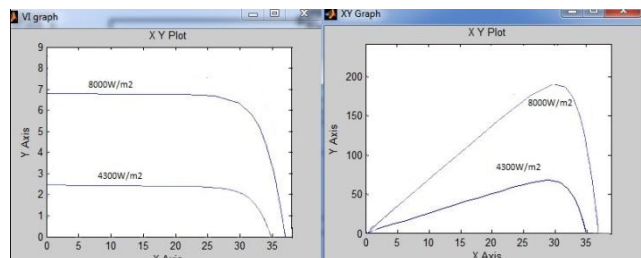

Fig 4. Variation in the power output with the variation in the irradiation

It has been observed that the power output of the module is proportional to the solar irradiation. Fig 5 shows the variation of power output with the ambient temperature changes. It has been observed that as the ambient

temperature changes the power output of the module decreases. Fig 6, Fig 7, Fig 8 shows the variation in the power output against the variation of series resistance, shunt resistance and the ideality factor.

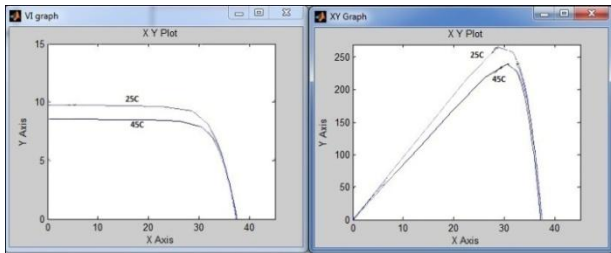

Fig 5. Variation in the power output with the variation in temperature

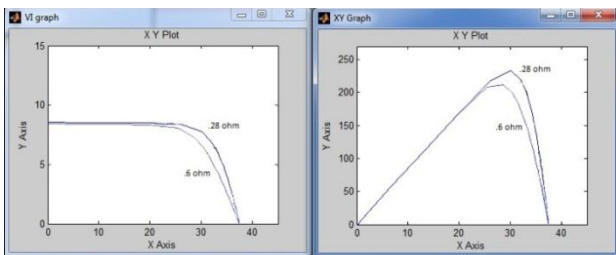

Fig 6. Variation in power output with the variation in series resistance

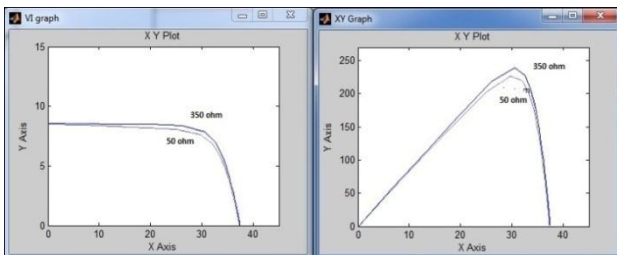

Fig 7. Variation in power output with the variation in shunt resistance

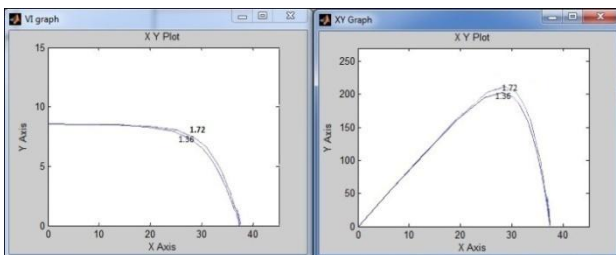

Fig 8. Variation in power output with the variation in ideality factors

We can observe that the series resistance is inversely proportional to the power output. When the series resistance increases the losses in the module also increases, causing the power to decrease. The higher shunt resistance values will give higher yields. When the shunt resistance value is decreases the leakage current value increase causing the yield to reduce. Ideality factor is a measure of the extent to which the module equations follows the ideal diode equation. Higher the ideality factor higher will be the yield. Fig 9 shows the variation in the irradiation during the month November and the Fig 10 shows the voltage, current, and the power output of the PV module.

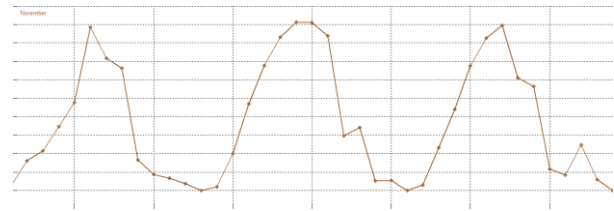

Fig 9. Variations in the solar irradiation during the month

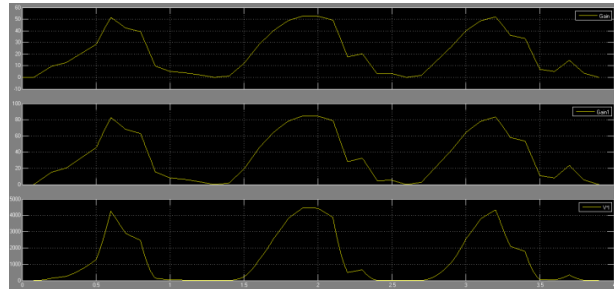

Fig 10. The current, Voltage and Power waveforms

Fig 11 shows the boost converter output waveforms and the Fig 12 shows the battery discharge characteristics for the same month.

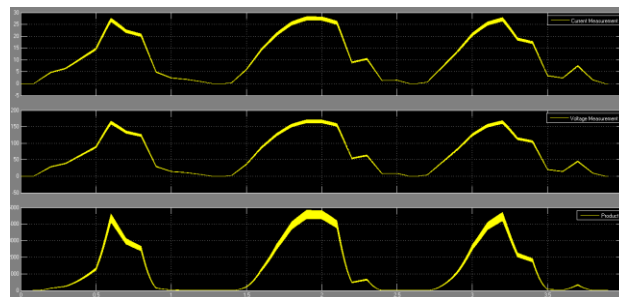

Fig 11. The output of the boost converter Current, Voltage, Power

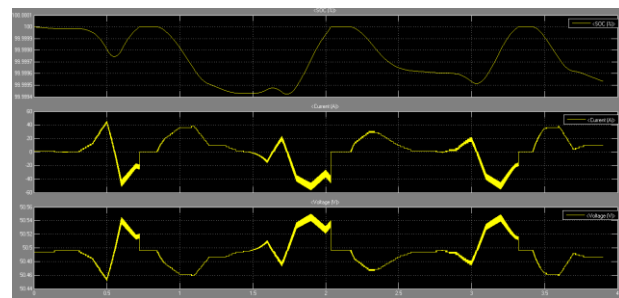

Fig 12. The battery SOC, Current, Voltage

Fig 13 shows the injected voltage to the grid. Due to the asynchronous switching of the inverters some amount of harmonics is generated. A filter is used in series with the inverter leg in order to mitigate the harmonics. Fig 14 shows the filtered the voltage waveform.

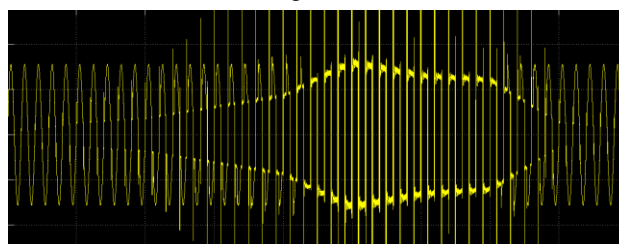

Fig 13. Injected voltage to the grid

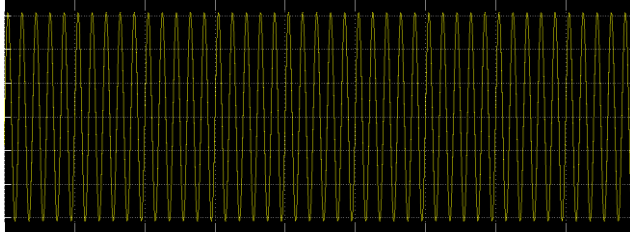

Fig 14. Filtered voltage output

IV. CONCLUSION

The SIMULINK model of a standalone and grid tied system is made. The dependence of various parameters on the output is analyzed. The various Voltages, Current and Power levels is recorded. Battery discharge characteristics give the information about the SOC, the depth of discharge, and the amount of energy flow in to the battery.

REFERENCES

- [1] Brig.M.R.Narayaoan, D.V.Gupta, R.C.Gupta & R.S.Gupta, "Design, Development and Installation of 100 kW utility grid connected solar PV plants for rural applications-An Indian experience". IEEE first world conference on Photovoltaic Energy conversion. Volume: 1. Page(s): 1073 – 1076, 1994.
- [2] D. Picault, B. Raison, and S. Bacha, "Guidelines for evaluating grid connected PV system topologies". IEEE International Conference on Industrial Technology. Page(s):pp. 1-5, 2009.
- [3] B. Marion, Adelstein, K. Boyle and fellows, "Performance Parameters for Grid-Connected PV Systems", Photovoltaic Specialists IEEE Conference, Page(s): 1601 -1606, 2005.
- [4] Phil Bolduc, David Lehmicke & Joseph Smith, "Performance of a grid – connected PV system with energy storage". IEEE Photovoltaic Specialists conference. Page(s):1159 – 1162, 1993
- [5] Cemal Keles, B. Baykant Alagoz, Murat Akcin, Asim Kaygusuz, Abdulkarim Karabiber," A photovoltaic system model for Matlab/Simulink simulations", Power Engineering, Energy and Electrical Drives (POWERENG), 2013 Fourth International Conference , May 2013, Page(s):1643 – 1647
- [6] Jenifer .A Newlin Nishia.R Rohini.G Jamuna, "Development of MATLAB Simulink Model for Photo Voltaic Arrays", International Conference on Computing, Electronics and Electrical Technologies [ICCEET], 2012, Page(s):436-442
- [7] Tarak Salmi, Mounir Bouzguenda, Adel Gastli, Ahmed Masmoudi, "MATLAB Simulink Based Model on Solar Photo Voltaics", International journal of renewable energy research, 2012
- [8] Francisco M. Gonzalez-Longat-2do congreso iberoamericano de estudiantes de ingenieria electrica, electronica y computacion, "Model of Photovoltaic Module in Matlab" (II CIBELEC 2005).
- [9] J.A Ramos-Hernanz,J.J. Campayo,J Larranaga ,E.Zulueta ,O. Barambones ,J. Motrico, U. Fernandez Gamiz, I. Zamora, "Two photovoltaic cell simulation models in Matlab/Simulink"- (JTPE), Iss.10, Vol.4, No. 1, Mar. 2012
- [10] N. Femia, G. Petrone, G. Spagnuolo, M. Vitelli, "Optimizing Sampling Rate of P&O MPPT Technique," Power Electronics Specialists Conference, PESC 04. 2004 IEEE 35th Annual, Volume 3, 20-25 June 2004, pp. 1945-1949.
- [11] Nashed, M.N.F, 'Low cost highly efficient of complete PV system', Power Conversion Conference, 2002, Volume 2, pp 845-849

BIOGRAPHY



Ajan.A is currently pursuing his Mtech in Christ University Bangalore. His specialization is Power Systems. He completed his Btech in Electrical and Electronics Engineering. Research interests are renewable energy, solar photovoltaics,

Energy conservation etc.,