

Modelling and Analysis of MPPT Techniques for Grid Connected PV Systems

Rakesh R¹, Kannan S A², Jomy Joy³, Kamala Devi V⁴, Prof.(Dr). Jayaraju M⁵

M Tech Scholar, Power Electronics, Toc H institute Of Science And Technology, Ernakulam, Kerala, India¹

M Tech Scholar, Power Electronics, Toc H institute Of Science And Technology, Ernakulam, Kerala, India²

M Tech Scholar, Power Electronics, Toc H institute Of Science And Technology, Ernakulam, Kerala, India²

Scientist, Agency for Non-Conventional Energy and Rural Technology (ANERT), Trivandrum, Kerala, India³

Director, Agency for Non-conventional Energy and Rural Technology (ANERT), Trivandrum, Kerala, India⁴

Abstract: This paper evaluates the most commonly used MPPT techniques and finds which MPPT technique is most suitable for grid connected systems. This paper presents the modelling of a Photovoltaic cell, dc to dc converter, and simulation study of a grid connected PV system. In this paper a new discrete time integral incremental conductance algorithm is proposed. Using mat lab/Simulink platform results are verified.

Keywords: Maximum Power Point Tracking (MPPT), Perturb and Observe algorithm (P&O), Incremental Conductance(IC), Fuzzy logic, Photovoltaic (PV).

I. INTRODUCTION

According to the present In order to maintain the economic growth rate of 8-9%, India needs to generate more and more of electric power. Nowadays Renewable Energy (RE) systems and technologies are gaining mass importance in the world. There are various types of RE technologies. RE generates either DC power or AC power depending upon the type and natural behaviour. The present scenario is tempting us to connect more and more RE systems to Grid. The most commonly used renewable energy resources is solar because it is noise free and clean due to this reason PV system which is gaining much more importance in the present condition. A typical solar cell which generally converts 30-40% of energy incident on it into electrical energy. Based on the type of semiconducting material that is used in a module its efficiency varies. Several types of semiconductor materials like C-SI, P-SI, A-SI, CIS etc. Cells that are connected in series which satisfies higher voltage requirements and that of parallel which gives higher current requirements. The maximum amount of power that can be extracted from a panel which depends on the solar irradiance, temperature, load so the input to the solar cell is basically irradiance and temperature of that particular area. Based on the isolation level and temperature maximum power output from a panel varies. The power output from a solar PV cell is typically very low and for extracting the maximum power output from a solar cell we are using MPPT technique. A particular MPPT technique is chosen based on the factors like simplicity, cost, quick tracking under varying atmospheric conditions, small power output locations etc. MPPT techniques which automatically find the voltage or current at

which maximum power point at which a PV module should operate. Under partial shading conditions [2] it is possible to have multiple local maximum at the same points so maximum power point shifts according to it. Most MPPT techniques would automatically respond to changes in both irradiance and temperature. Among these some techniques are more useful. So we have to find which technique is most suitable for the present conditions and comparing the results with that of other. This paper analyse through results which MPPT technique is most suitable for the grid conditions under normal and varying atmospheric conditions. Now a day's grid connected systems which are most common and it is very useful for residential and industrial purposes due to that for getting maximum power output from PV module MPPT techniques are used. The main problems solved by the MPPT technique are that it automatically finds out the maximum voltage and current from the PV panel such that it operates under maximum power point. The most commonly used MPPT algorithms are Perturb and Observe algorithm, Incremental Conductance algorithm, Fuzzy logic algorithm. For a grid connected system there are two stages first stage is the boosting stage that is the output from a solar PV module is boosted according to the requirements. And the Second stage is dc to ac conversion stage. When a PV system is interconnected to the utility network system the main demands to that type of system are power quality and power system stability. For a PV grid connected system there are certain protection schemes that are implemented which particularly includes Anti islanding protection, Voltage fluctuations like sag swell, Overvoltage and Over current protection. These protection schemes that are

basically included to isolate the PV system components in the case when a grid fault occurs. For an ON Grid interacted system PV inverters helps to inject energy directly into the grid and it acts us a controlled power source which helps to inject constant power into the grid which works very close to unity power factor. Hence this paper access and finds which MPPT technique holds better power output when connected to grid and is analysed through mat lab/Simulink. For this five commonly used MPPT techniques are chosen and power output, current, voltage is compared. Efficiency of the whole system which depends up on the type of converter that is used. For PV connected system we commonly used boost converter because of its simplicity. In this scenario a new discrete time integral incremental conductance algorithm is also proposed.

II. PHOTOVOLTAIC SYSTEM COMPONENTS

Due to uncertainty in the in global supply of fossil fuels, a continued increase in energy consumption and growing awareness of environmental deterioration we use PV system. Solar PV is a semiconductor device consisting of an array of cells which directly converts solar radiation into electricity without any intermediate steps. Higher the intensity of the sunlight, the more the amount of electricity generated from it [1]. Amount of electricity generated (say, 1milli watt to several megawatts) which depends on the size of the PV module. PV system which does not contain any movable parts and hence it requires very little maintenance. Main limitation for a PV module is Non-continuous supply of input source of energy also its installation cost is very high

A. Equivalent Circuit Of a Solar Cell

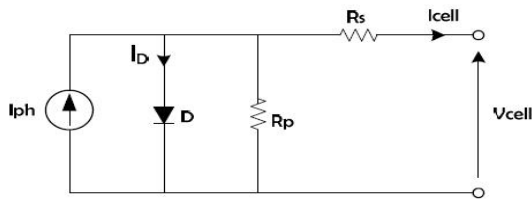

Fig 1: Equivalent Circuit

Equivalent circuit of a solar cell that can be treated us a current source, a diode , a parallel resistor expressing in terms of leakage current and also consisting of a series resistor describing an internal resistance which helps the current to flow. Diode which represents dark current.

$$I = I_{ph} - I_r \left[e^{\frac{q(V + IR_s)}{nkT}} - 1 \right] - \frac{V + IR_s}{R_p} \quad (1)$$

Where

I_{ph} is the photoelectric current

I_s is the cell saturation dark current

$q = 1.6 \times 10^{-19}$

T_c is the cell working temperature

A is ideal factor

R_{sh} is the shunt resistance

R_s is the series resistance

The photo electric current mainly depends on solar isolation and cell's normal working temperature on a particular area which is related by

$$I_{ph} = [I_{sc} + k_1(T_c - T_{ref})]H \quad (2)$$

Basically cell saturation current varies with that of temperature us

$$I_s = I_{RS} \left(\frac{T_c}{T_{ref}} \right)^3 e \left[\left(\frac{qE_g(T_c - T_{ref})}{T_{ref} T_c K A} \right) \right] \quad (3)$$

A PV array is a group of cells that are connected in series or parallel to get the required output such an equivalent circuit is shown in figure. A number of solar cells that are connected in series or parallel to obtain the required output.

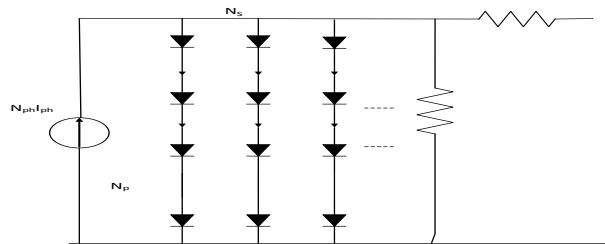

Fig 2: Equivalent Circuit of a number of solar cells in series and parallel

$$I = N_p I_{ph} - N_p I_s \left[e^{\frac{q(V/N_s + IR_s/N_p)}{kTCA}} - 1 \right] - \frac{N_p V / N_s + IR_s}{R_{sh}} \quad (4)$$

A typical PV IV characteristic of a solar cell is shown in figure based on varying solar irradiation and temperature changes. A solar cell is modelled based on the equivalent circuit.

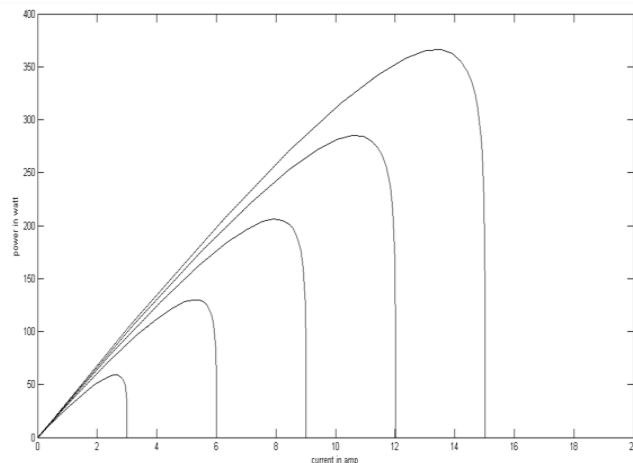

Fig 3: PV Characteristics



Fig 4: IV Characteristics

III. BOOST CONVERTER

For a grid connected PV system the first stage is the boosting stage in which the input voltage from the PV panel is boosted. Basically a dc-dc converter which acts as an interface between the load and the PV module. The maximum power point tracking is basically a load matching problem in which our basic requirements are obtained. In order to change the input resistance of the panel to match the load resistance (by varying the duty cycle) that is tracking the maximum power, a DC to DC converter is basically required. Due to more flexibility, better performance and ease of implementation a boost converter is generally used for PV grid connected systems. In the case of a buck converter the current is not flowing constantly and it is continuously varying. Compared to other type of converters boost converter which provides maximum efficiency.

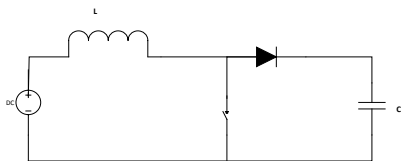

Fig 5: Boost Converter

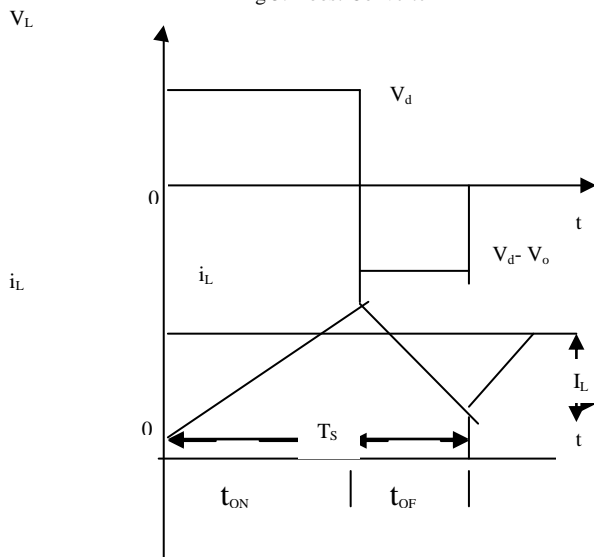

Fig 6: Wave Forms

$$\begin{aligned}
 V_d * T_{on} + (V_d - V_o) T_{off} &= 0 \\
 V_d * T_{on} + V_d T_{off} - V_o T_{off} &= 0 \\
 V_d (T_{on} + T_{off}) - V_o T_{off} &= 0 \\
 V_d T &= V_o T_{off} \\
 V_o / V_d &= T / T_{off} \\
 V_o / V_d &= 1 / (1 - D)
 \end{aligned}$$

Where D is the duty ratio

IV. MAIN MPPT TECHNIQUES

MPPT techniques are commonly used to find out the voltage and current at which maximum power point of a PV module occurs. Using MPPT techniques with solar panel which have clear advantages such that initial investment is much smaller because smaller panel wattage power is required. Maximum power point of a particular solar photovoltaic module lies about 0.75 times which is greater than its open circuit voltage. Maximum amount of power that can be extracted from a panel which depends on certain factors like SOLAR IRRADIANCE: It is the measure of how much solar power that we have obtained from a particular area and also it depends on certain natural factors. TEMPERATURE: It mainly depends on panel operating point at which maximum power is obtained.

There are different techniques used to track the maximum power point. The choice of the algorithm depends on the time complexity of the algorithm to track the Maximum power, Implementation cost, Simplicity, Ability to track maximum power under varying atmospheric conditions. Some techniques are useful. Among these the most commonly used MPPT algorithms are

1. Perturb and Observe algorithm
2. Incremental conductance algorithm
3. Fuzzy logic method

A. PERTURB AND OBSERVE METHOD

Perturb & Observe (P&O) is the simplest method and is widely used. In this technique we generally use only one sensor, that is the voltage sensor, to sense the PV module voltage and hence the cost of implementation is less and hence easy to implement without any complexity [3]. The time complexity of this algorithm is very less for calculating the maximum power but on reaching very close to the Maximum Power Point (MPP) it doesn't stop at the MPP and keeps on perturbing on both the directions so for that reason it have multiple local maximum at the very same point. First of all the algorithm which reads the value of the current and voltage from the photovoltaic module from that power is calculated the value of voltage and power at that instant is stored. Hence a slight perturbation is added in the increasing direction. The next values at the next instant are measured and power is again calculated. Hence by adjusting the maximum power duty cycle can be obtained based on it. In certain situations like changing atmospheric conditions and change in irradiance the maximum power point shifts

from its normal operating point. In the next iteration it changes its direction and goes away from the maximum power point and results in multiple local maxima at the same point. So the maximum power point deviates from its original position. This difficulty which can be overcome by using an improved P&O method.

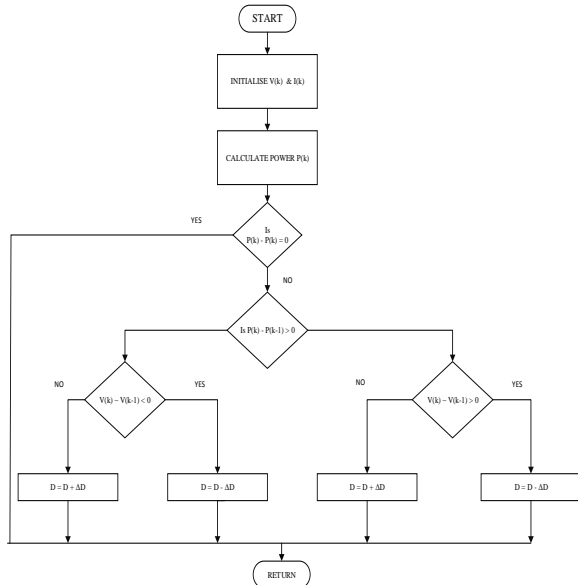

Fig 7: Flow Chart P&O

B. INCREMENTAL CONDUCTANCE METHOD

Incremental conductance method generally uses voltage and current sensors to detect the output voltage and current of the PV array hence the complexity of the algorithm increases. The slope of the PV curve is zero at Maximum Power Point. The left hand side which represents the instantaneous conductance of the solar panel. When this instantaneous conductance equals the conductance of the solar PV module then MPP is reached. Here we are sensing both the voltage and current simultaneously. Hence the error due to change in irradiance is eliminated completely so there is no multiple local points at MPP. If the panel power [4] derivative versus voltage is zero it is the point at which maximum power point is obtained. Similarly if the panel power derivative versus voltage is positive it is located on the left side and if it is negative it is in the right side. So the main idea behind this algorithm is to compare the incremental conductance with that of instantaneous conductance depending on their comparing result the operating voltage of the panel is either increased or decreased until at which maximum power point is obtained. By checking this duty ratio is adjusted based on the shift in position of maximum power point. The main advantage of this method is it can rapidly track the change in irradiance conditions and respond quickly with a very high accuracy and hence efficiency of the system is better and give better results. However the complexity and the cost of

implementation increase. Incremental Conductance method of tracking maximum power point which does not depends on PV module.

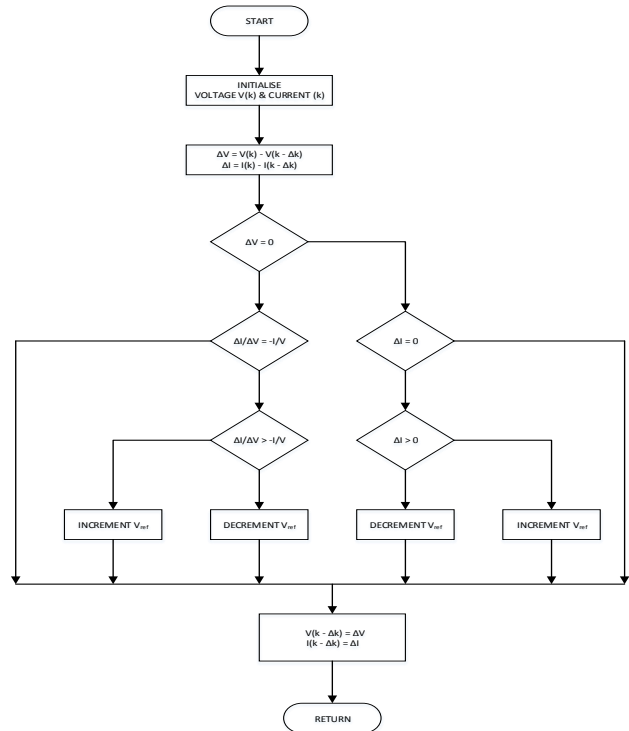

Fig 8: Flow Chart Incremental Conductance

C. FUZZY LOGIC METHOD

Fuzzy logic control algorithm is one of the most popular control algorithm methods which is known by its multimode based variable control algorithm. Fuzzy logic control algorithm is Photovoltaic array dependent. This algorithm is based [7] on the operators experience because this algorithm is followed by certain rules that are given by the operator. It helps to improve the response of a photovoltaic system. The main disadvantage of this method is that the efficiency of the whole system which depends on the operators performance and the precision of the rules.

Fuzzy logic control mainly consists of four stages namely Fuzzification, rule base, inference, defuzzification. First of all we have to initialize the inputs to the Fuzzy logic controller. The main step behind fuzzy logic control is to create seven fuzzy subsets like Negative Big, Negative Medium, Negative Small, Zero, Positive Small, Positive Medium and Positive Big. Then certain rules based on operator's precision are written based on it and calculate duty ratio based on it. MPPT using Fuzzy Logic Control gains several advantages of better performance, robust and simple design.

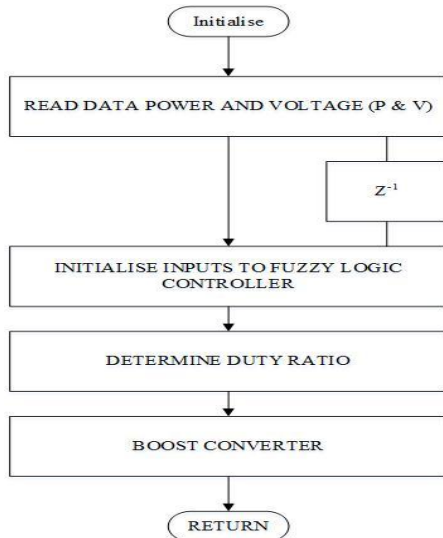

Fig 9: Flow Chart Fuzzy Logic

D. GRID CONNECTED SYSTEM

Recently grid connected photovoltaic system have been spreading in residential areas and in industrial areas. So we have to find a suitable MPPT technique that gives a better power output when connected is to find out. For a grid connected system there are certain factors that have been considered such that DC-AC conversion with highest output power quality with the proper design of filters System main controlling factors like MPPT. Comprehensive protection functions including Anti islanding protection and accelerated phase shift protection. Grid interface inverters which transfers the energy from the photovoltaic module to the grid by just keeping the dc link voltage which is to be maintained constant. For a grid connected system the utility network mainly demands for better power quality and power output. In the case of voltage fluctuations control of grid parameters is very difficult. So for a PV system that is connected to a grid first stage is the boosting stage and the second stage is DC-AC converter. An output filter is usually employed which reduces the ripple components due to switching problems.

The problem associated with the grid connected system is that the dc link voltage that must be oscillates between the two levels which depends on the operating climatic conditions (ambient temperature & irradiance) in which inverter which acts us a power controller between the dc link and the utility [6]. Dc link is generally used to isolate between the grid side and the inverter side so that we can control both PV system [6] and grid separately. All the available power that can be extracted from the photovoltaic system is transferred through the grid. In the case of a distributed power generation system that is connected to a grid the grid frequency and the grid voltage that can be controlled by simply adjusting the active and reactive power. The reference reactive power is typically set to be zero in order to achieve zero phase angle between voltage and

current such that unity power factor can be achieved it is the main requirement. Next main factor to be considered is synchronization which is basically achieved by using a phase locked loop. In grid tied inverter synchronization and Anti Islanding protection which is to be provided to protect the inverter from over load. Synchronization which is achieved by various methods such us filtering the grid voltage using phase locked loop and by using zero crossing detector. MPPT techniques which analyses the performance of a grid connected system.

V. SIMULATION RESULTS

In order to find which MPPT technique is better when connected to grid first of all PV module is modelled in mat lab/Simulink based on the equivalent circuit. Input to the PV module is solar insolation and temperature. From the solar panel voltage and current are extracted in order to find the power output.

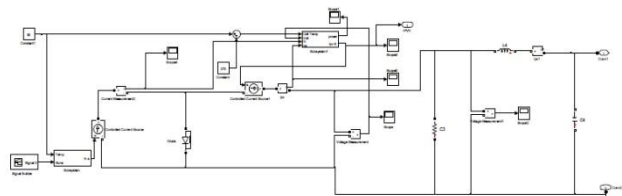
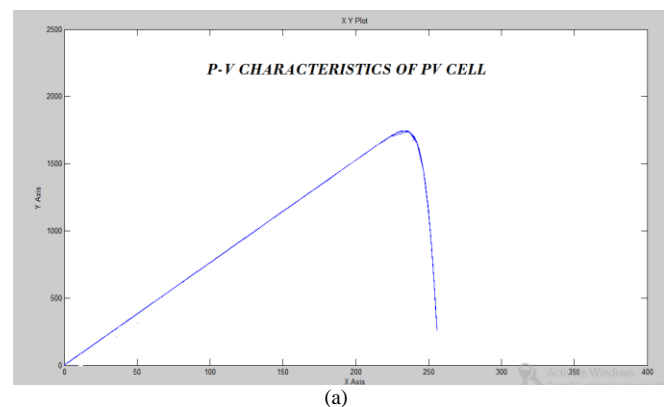

Fig 10: PV Model

From the equivalent circuit PV module is modelled in mat lab/Simulink platform and typical PV,IV characteristics is analysed the design specifications of the simulated PV module is shown in the table

TABLE I
DESIGN SPECIFICATIONS OF PV MODULE

Characteristics	Specifications
Power output	1860 W
Short circuit current	8 A
Open circuit voltage	261 V
Voltage at peak power	7.1 A
Current at peak power	230 V
Temperature coefficient	0.008 A/C



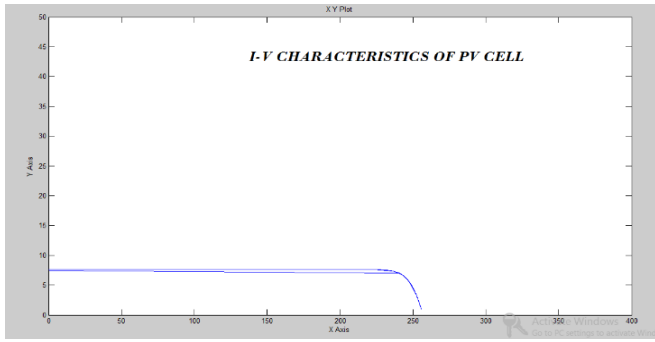

Fig 11: Output waveforms of the PV Module
(a) PV characteristics (b) IV characteristics

PV module is analysed and gives better results. Then each algorithm are implemented in mat lab/Simulink platform and the power output, voltage and current is compared and finds out which algorithm which gives better results when connected to grid under constant and varying atmospheric conditions.

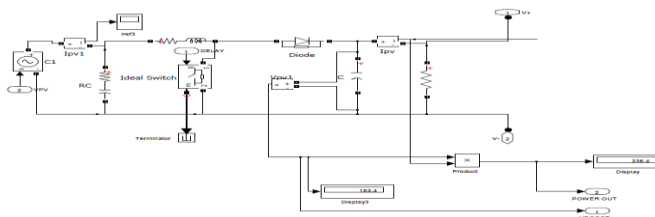

Fig 12: Boost Converter

GRID CONNECTED SYSTEM

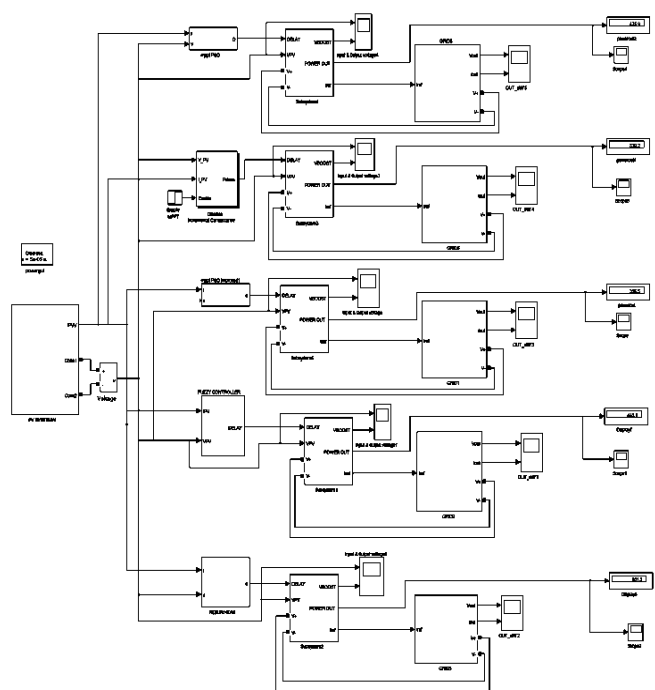

Fig 13: Grid Connected system with different MPPT Techniques

TABLE II
COMPARISON BETWEEN DIFFERENT MPPT TECHNIQUES UNDER CONSTANT ATMOSPHERIC CONDITIONS

Algorithm	Current	Voltage	Power
P&O	2.38 A	194.8 V	463.7 W
Improved P&O	2.37 A	194.7	463.2 W
Incremental Conductance	2.93 A	226.9 V	666.1 W
Discrete IC	2.07 A	183.4 V	381.4 W
Fuzzy Logic	2.31 A	194.5 V	450.8 W

TABLE III
COMPARISON BETWEEN DIFFERENT MPPT TECHNIQUES UNDER VARYING ATMOSPHERIC CONDITIONS

Algorithm	Current	Voltage	Power
P&O	1.91 A	190.8 V	364.1 W
Improved P&O	1.90 A	190.1 V	361.4 W
Incremental Conductance	2.64 A	264.7 V	700.8 W
Discrete IC	1.83 A	183.4 V	336.4 W
Fuzzy Logic	1.91 A	191.5 V	366.9 W

Each algorithm is implemented in mat lab/Simulink plat form then the power output, voltage and current outputs of each algorithm is analyzed when connected to grid. From the simulation results we can found that INCREMENTAL CONDUTANCE algorithm which gives better power output under normal and varying atmospheric conditions.

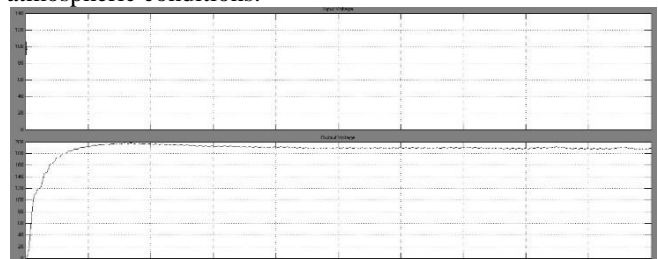

(a)

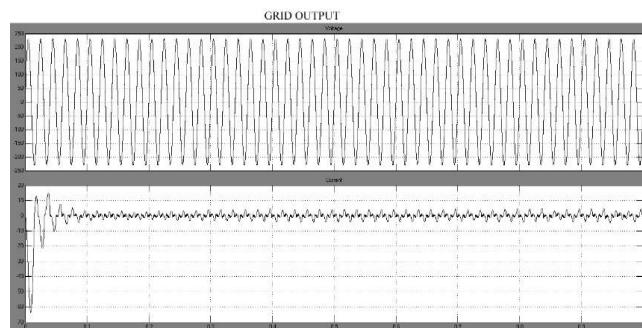

(b)

Fig 14: Output waveforms of Grid Connected System Using Incremental Conductance Method

(a) Boost Converter Input And Output Voltage Waveforms (b) Grid output And Input voltage Wave Form

Figure 13(b) shows the grid output voltage and output current of an Incremental Conductance algorithm which gives a better output under normal and varying atmospheric conditions. Figure 13(a) shows the boost converter input and output voltage waveforms of Incremental Conductance algorithm when connected to grid. From the waveforms and simulation results we can conclude that Incremental Conductance algorithm which gives better output and efficiency when compared to other algorithms.

VI. CONCLUSION

Based on the simulation results we can find that Incremental Conductance algorithm which holds good performance than any other methods under normal and varying atmospheric conditions. Power output obtained from incremental conductance method is high as compared to other methods under varying atmospheric conditions. For a grid connected Photo voltaic system Maximum Power Point Tracking algorithm which plays a major role. A most suitable MPPT technique is chosen based on the implementation cost, number of sensors required, complexity. So for residential and industrial purposes INCREMENTAL CONDUCTANCE ALGORITHM performs better results.

REFERENCES

- 1]. Bidyadhar Subudhi, Senior Member, IEEE, and Raseswari Pradhan "Comparative analysis of MPPT techniques for PV applications" Clean Electrical Power (ICCEP), 2011 International Conference on Digital Object
- 2]. Moacyr Aureliano Gomes de Brito, Luigi Galotto, Jr., Leonardo Poltronieri Sampaio, Guilherme de Azevedo e Melo, and Carlos Alberto Canesin, Senior Member, IEEE. "Evaluation of the Main MPPT Techniques for Photovoltaic Applications" IEEE TRANSACTIONS ON INDUSTRIAL ELECTRONICS, VOL. 60, NO. 3, MARCH 2013
- 3]. R. Faranda, Member, IEEE, S. Leva, Member, IEEE and V. Maugeri "MPPT techniques for PV Systems: Energetic and cost comparison" Power and Energy Society General Meeting - Conversion and Delivery of Electrical Energy in the 21st Century, 2008 IEEE.
- 4]. Trishan Eswar, Student Member, IEEE, and Patrick L. Chapman, Senior Member, IEEE "Comparison of Photovoltaic Array Maximum Power Point Tracking Techniques" IEEE TRANSACTIONS ON ENERGY CONVERSION, VOL. 22, NO. 2, JUNE 2007
- 5]. Yang Haizhu and Liu Jie Department of Electrical Engineering and Automation, Henan Polytechnic University, Jiaozuo 454000, China "Research on Maximum Power Point Tracking Control Based on the Low Power Photovoltaic Grid connected Inverter"
- 6]. Yang Haizhu and Liu Jie "Research on Maximum Power Point Tracking Control Based on the Low Power Photovoltaic Grid connected"
- 7]. Pongsakorn Takun, Somyot Kaitwanidvilai and Chaiyan Jettanasen "Maximum Power Point Tracking using Fuzzy Logic Control for Photovoltaic Systems"

BIOGRAPHIES



Rakesh. R was born in Kerala, India in 1991. He obtained his bachelor degree from Kerala University, Trivandrum. He is currently pursuing his Masters degree in Power electronics from Cochin University of science and technology, Kerala. His area of interest includes power electronics, electrical drives and control system.



Kannan S A was born in Kerala, India in 1990. He has graduated in B-Tech in Electrical & Electronics Engineering from Kerala University during 2012. He is currently pursuing his Masters degree in Power electronics from Cochin University of science and technology, Kerala. His area of interest includes power electronics, electrical drives and control systems.



Smt. Kamala Devi V. has graduated in B-Tech in Electrical & Electronics Engineering from Kerala University during 1992. She was ranked third in the university during the year. She did M-tech in Control Systems from Kerala University during 2003. At present she is working as Scientist in Solar division of Agency for Non-conventional Energy and Rural Technology (ANERT), Trivandrum, Kerala, India.



Prof. (Dr.) M. Jayaraju, Ph.D, FIE, FIV, M IEEE, FISLE, MISTE, (Chartered Engineer, Energy) is a Consultant, approved Valuer approved Research Guide. Being former Professor of Dept. of EEE, TKM College of Engg., Kollam, Kerala, India, he has served as Principal of MES Institute of Technology & Management, Chathannoor, Kollam - 691572, Kerala, India. He is at present serving as Director of Agency for Non-conventional Energy and Rural Technology (ANERT), Trivandrum, Kerala, India.