

“Smart Guiding System for Blind”

M K Pushpa¹, Shunmuga Priya M², Nandini T G³, Shilpa C K⁴, Sunitha⁵

Associate Professor, Department of Electronics & Instrumentation Engineering, M S Ramaiah Institute of Technology,
Bangalore, India¹

UG Student , Department of Electronics & Instrumentation Engineering, M S Ramaiah Institute of Technology,
Bangalore, India^{2,3,4,5}

Abstract: This paper presents a Smart system for visually impaired, that make use of ultrasonic sensor and RF transceiver as assistive devices. Visually impaired individuals find navigation difficult as they struggle everyday in performing actions for bypassing obstacles and hurdles in their path. In order to help blind people navigate safely and quickly this system is proposed. This system is based on embedded technology. Ultrasonic sensor is placed on the spectacle which is used for obstacle detection with distance indication. RF transceiver simulator is used to provide the traffic signal information for pedestrian crossing in real time scenario and also the bus route information to help the user know about the desired bus. The project hypothesizes a smart walking stick that alerts visually-impaired people over ground level obstacles, pit and water in front which could help them to walk with less accident. The main aim of this work is to design a voice based alerting system for the blind people.

Keywords: Smart system, Assistive devices, Embedded system, Microcontroller, Ultrasonic sensor, RF transceiver, APR sound system.

I. INTRODUCTION

Blind mobility is one of the main challenges encountered by visually impaired persons in their daily lives. The blind people life and activities are greatly restricted by loss of eyesight.

They can only walk in fixed routes that are significant in their lives, with blind navigation equipments and the accumulated memories in their long-term exploration.

Crossing at urban intersections is a difficult and possibly dangerous task for the blind, hindering independent safe navigation. Assistive technology researchers have been working on this problem for years, not many of the proposed solutions being widely adopted.

There are approximately 37 million people across the globe who are blind, over 15 million are from India. Currently most blind people rely on other people or dogs. Many disabled people prefer to do things independently rather than rely on others. The Smart Guiding System for Blind can provide a solution to this problem.

The main objective of the project is to develop a low cost, reliable, portable, user friendly, low power and robust solution for smooth navigation.

This paper is organized as follows: Section I describes the introduction, Section II illustrates the proposed system with the block diagram and its explanation, Section III describes the methodology of the work with each sub units.

Result and discussion of each sub unit is described in Section IV and finally the conclusion and future work of the project is illustrated in section V.

II. THE PROPOSED GUIDANCE SYSTEM

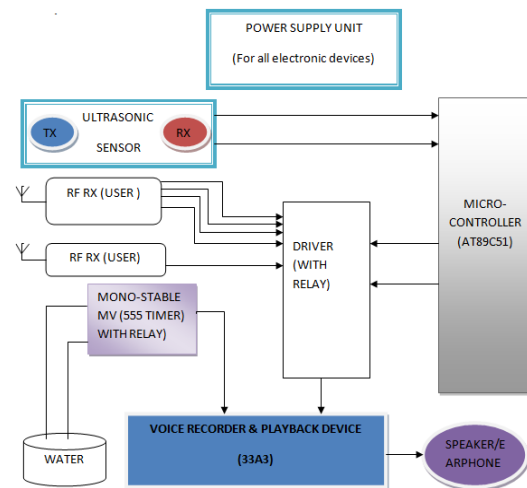

Figure 1: Block diagram of Smart Guiding System for Blind

Figure 1 shows the proposed Smart guiding system for blind. The system needs ultrasonic sensor pairs, RF transceiver, 555 timer circuitry, APR33A3 audio recording and playback flash memory, earphone with AT89S52 microcontroller. Ultrasonic sensor senses the obstacles in vision of sight by continuously transmitting the ultrasonic waves. If any obstacle comes in its vicinity then the ultrasonic waves gets reflected back to the system. The ultrasonic receiver senses these ultrasonic waves and this information is passed as a high pulse to the Microcontroller.

The microcontroller gives alerts based on distance of the obstacle through voice messages. RF based unit is used for providing signal information to the blind and visually

impaired pedestrians at traffic signal intersections. As soon as the walk sign is on, the speech messages about the traffic signal is conveyed to the blind. For bus route information, a radio-frequency based solution has been developed to help the user to know desired bus. A 555 timer module placed on the smart walking stick is used as a water detector.

III. METHODOLOGY

The proposed system consists of four sections i.e

- A. Obstacle detection unit
- B. Traffic signal information unit for pedestrian crossing
- C. Bus route information unit
- D. Water detection unit

A. Obstacle Detection Unit.

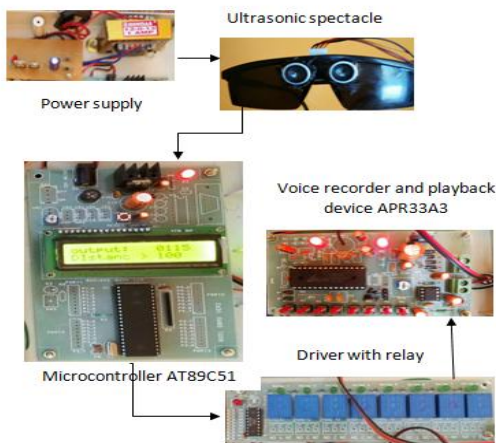

Figure 2 : Obstacle detection unit

In this system, ultrasonic sensor is used to detect the obstacles in the path of a blind person. Ultrasonic sensor HC-SR04 is a 4 pin device which is placed on the spectacle as shown in figure 2. The pin1 of the sensor is connected to power supply of 5v dc, the pin2 of the sensor is connected to P3.5 pin of microcontroller AT89c51 to trigger ultrasonic sensor, pin3of the sensor is connected to P3.2 pin of microcontroller which receives echo's in the form of high pulse when any obstacle is detected and pin4 is connected to ground.

Ultrasonic sensor which is used to detect obstacle from the user position consists of 3 major parts: A transmitter, a receiver and a timer. To measure a distance the timer triggers the transmitter which emits a series of pulses, and then the timer waits until the receiver detects the reflection of the pulses and stops the timer.

The time measured is then divided by 2 and multiplied with the speed of sound. The result is the distance between the sensor and the object in front of it.

The output of the microcontroller energizes the relay coil through the driver ULN2003 IC which activates the voice module and thereby the speech message about the detected obstacle is conveyed to the blind person.

The distance is calculated as explained in section(i).

(i) Distance Measurement:

The relationship between distance, time and speed is represented by equation 1. Distance calculated is twice the actual distance because it includes returning time also. Hence, only half of the distance is considered to indicate actual distance from the user to an obstacle. Using equation 1 the distance is calculated.

$$D = [(Elapsed\ time) * (SV)/2] \text{ ----- (1)}$$

Where,

D = Distance in cm

SV = Sound velocity in cm/s

Elapsed time= time taken by the sensor to send and receive the ultrasound wave.

B. Traffic Signal Detection Unit for Blind Pedestrian.

This work needs the user near the traffic pole should stand in the following manner.

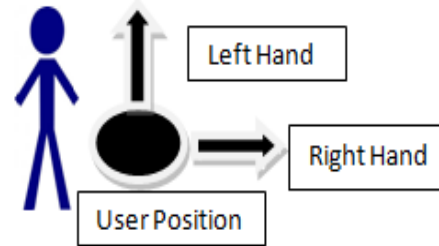

(i) Transmitter Section:



Figure 3: Prototype of Four way road with RF transmitter module

The RF transmitter module is assumed to be placed on the traffic pole which is shown in figure 3. The ASIC transmitter IC has 4 inputs and one output pin. The 4 inputs which are provided by the traffic controller is considered as the traffic signal for the pedestrian (Green pedestrian signal ON).

Frequency range of 17khz, 19khz, 22khz and 25Khz with four switches are provided for each range. In this application, DPDT toggle switches are used to control the traffic signal of the four way road manually.

DPDT toggle switch has two inputs in which one input is to glow the green light and the other is used to activate the frequency range. The activated RF frequency is added with the carrier frequency of 49MHz and then transmitted through telescopic antenna.

(ii) Receiver Section :

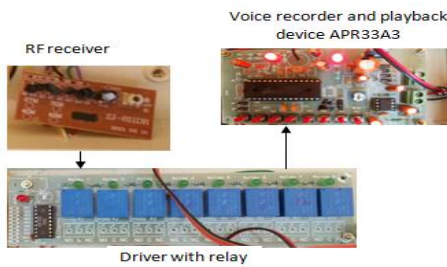

Figure 4: RF receiver module

The RF receiver module is as shown in figure 4. This module is with blind person which is also built around the ASIC IC. The loop antenna receives the transmitted signal from the traffic pole. These signals are fed to the ASIC IC which demodulates the received signal and remove carrier frequency of 49MHz. The extracted frequency is further fed to the driver stage. The output of the RF receiver energizes the relay coil through the driver ULN2003 IC which activates the voice module and thereby the speech message about the Traffic Signal is conveyed to the blind person.

C. Bus Route Information Unit:

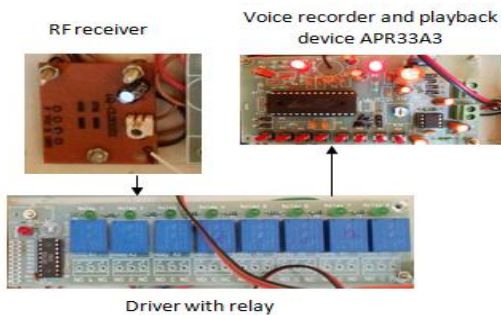

Figure 5: Bus route information unit

The bus route information module is as shown in figure 5. The 2 channel RF transceiver is used for the bus route information unit. It consists of two modules: a transmitter module installed inside the bus and a receiver module with the user. Once at a bus stop, when the transmitter's frequency matches with the receiver's frequency the information about the bus route is obtained. These numbers are read out to the user via a speaker / head phone in the user module. This essentially solves the problem of helping the user know if the desired bus is there at the bus terminal or not.

D. Water Detection:

The 555 timer IC is the heart of the water detection unit which acts as monostable multivibrator. Two conducting wires are used to sense water i.e., one wire is connected to pin no 2 and the other wire is connected to ground. The output pulse begins when the 555 timer receives a signal at the trigger input as more than 1/3 of Vcc (negative trigger pulse). The width of the output pulse is determined by the time constant of RC network, which consists of a capacitor(C) and resistor(R). Figure 6 shows the entire water detection unit.



Figure 6: 555 timer used as a water detector

The output pulse ends when the voltage on capacitor equals 2/3 of the supply voltage. The output pulse width can be lengthened or shortened to the need of the specific application by adjusting the values of R and C. The output pulse width of time t, which is the time it takes to charge C to 2/3 of the supply voltage, is given by equation (2)

$$t = RC \ln(3) \sim 1.1RC \quad \text{-----(2)}$$

Where t is in seconds, R is in ohms, C is in farads.

When water is sensed, the output of the monostable multivibrator goes high, it energizes the relay coil which activates the voice module and thereby the speech messages about the water detection is conveyed to the blind person.

IV. RESULTS AND DISCUSSION

The experiment is conducted to evaluate the performance of the proposed method. A system prototype is developed as shown in figure 7 and 8. The ultrasonic spectacle effectively calculates the distance when an obstacle is detected. The sample speech messages are shown in Table 1. A simple user interface is designed to accommodate the need of blind pedestrians to cross the road effectively.



Figure 7: Ultrasonic Spectacle with HC-SR04 ultrasonic sensor

Table 2 shows the sample speech messages for person position. For water indication electrodes are fitted at the bottom of the stick. These electrodes sense water and thereby information is conveyed to blind people through voice feedback.

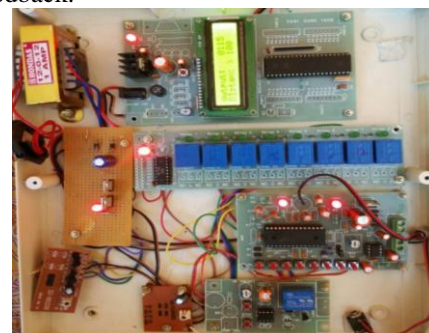

Figure 8: Smart guiding system prototype



Figure 9: Distance displayed on the LCD screen

Figure 9 shows the distance of the object from obstacle is displayed on the LCD screen. For distance greater than 100cm speech message will not be conveyed to the blind (distance shown in LCD for our reference). The sample speech messages which are conveyed to the blind are shown in Table 1.

Table 1: Speech messages for Obstacle Detection

Sl. No.	Distance in cms	Speech Message
1	Distance less than 50 cm	Object is very nearer
2	Distance less than 100cm	Object is at 1m distance

a. Consider a sixty feet four way road:

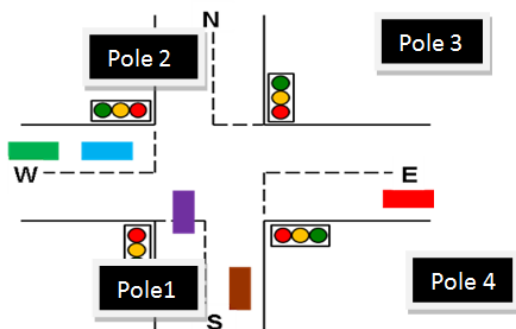

Figure 10: Four way road

Table 2: Person position and sample speech messages

Person position	Walk Sign (Green)			
	Pole1	Pole2	Pole3	Pole4
Pole1 or Pole3	Move 30 steps to your left or right	-----	Move 30 steps to your left or right	-----
Pole2 or Pole 4	-----	Move 30 steps to your left or right	-----	Move 30 steps to your left or right
Pole 2	Move 30 steps to your left or right	-----	-----	-----
Pole 4	-----	-----	Move 30 steps to your left or right	-----

V. CONCLUSION AND FUTURE WORK

The main objective of this project is to assist blind or visually impaired people to safely move among obstacles and other hurdles faced by them in their daily life. The

smart system has been tested in laboratory environment. Using this guiding system the blind people can travel in the unknown areas independently. Less training time period is required to use this smart system. The solution developed is a low cost and user friendly navigational aid for the visually impaired. In future GPS based bus information module with user request can be designed. Entertainment panel (like music) can also be provided.

ACKNOWLEDGEMENT

This is a funded project by the Alumni association M.S.R.I.T Bangalore. We would like to express our deep sense of gratitude towards Alumni association M.S.R.I.T Bangalore

REFERENCES

- [1]. Amit kumar, M. Manjunatha and J. Mukhopadhyay, "An Electronic Travel Aid for Navigation of Visually Impaired Person," Proceeding of the 3rd International Conference on Communication Systems and Networks, pp.1-5, 2011.
- [2]. Shripad S. Bhatlawande, Jayant Mukhopadhyay and Manjunatha Mahadevappa, "Ultrasonic Spectacles and Waist-belt for Visually Impaired and Blind Person", Communications (NCC), National Conference, February 2012
- [3]. Mohd Helmy Abd Wahab, Amirul A. Talib, Herdawatie A.Kadir, Ayob Johari, A.Noraziah, Roslina M. Sidek, Ariffin A. "Smart cane: assistive cane for visually impaired people", IJCSI, Vol.8 Issue 4, July 2011.
- [4]. F. van der Heijden, P.P.L. Regtien, "Wearable navigation assistance - a tool for the blind" MEASUREMENT SCIENCE REVIEW, Volume 5, Section 2, 2005
- [5]. I. Ulrich, and J. Borenstein, "The guide cane-Applying mobile robot technologies to assist the visually impaired," IEEE Transaction on Systems, Man, and Cybernetics-Part A: Systems and Humans, vol. 31, no. 2, pp. 131-136, 2001.