

Design & Development of an efficient inverter System for Single-Phase Non-Conventional Energy System

BINDU B¹

Research Scholar, Department of Electrical and Electronics Engineering, PSG College of Technology, Coimbatore, Tamil Nadu, India¹

Abstract: This paper proposed a transformer less inverter for use in residential solar energy systems. There is a strong trend in the photovoltaic (PV) inverter technology to use transformerless topologies in order to acquire higher efficiencies combining with very low ground leakage current. The operation principle, control strategy and characteristics of the system are described. The new and traditional system configuration has compared in this paper. Analysis and simulation results will be presented to demonstrate the new features. An improvement in inverter efficiency and a reduction in cost have been achieved by omitting the 50 Hz power transformer (transformerless). The design and control issues associated with the development of a 40 W prototype single-phase stand alone photovoltaic system is discussed in this paper. Voltage level controller and PWM inverter systems have been realized by using PIC16F877A microcontrollers. An experimental system was implemented to demonstrate the effectiveness of the proposed system. Simulation and experimental results are given to verify the system's efficiency. Simulated model for system is designed using MATLAB Simulink. The paper focuses on some known problems and challenges for transformerless inverters. Topologies without transformers have big advantages like low weight, volume and cost. In addition they often reach higher efficiencies than topologies with transformers. Therefore they are important for future developments.

Keywords: DC–AC power conversion, photovoltaic (PV) systems, transformerless inverter, PIC microcontroller, DC-DC Converter, Solar energy.

I. INTRODUCTIONS

The oil, coal and gas price keeps rising and global warming becomes more severe due to the pollution, people start to look into alternative energy sources beside the fossil fuel. In recent years, the problem of energy crunch has become more and more aggravating, resulting in increased exploitation and research for new power energy resources around the world. Natural resources in the world have depleted rapidly as mankind venture into the new millennium. The energy consumption is steadily increasing and the deregulation of electricity has caused that the amount of installed production capacity of classical high power stations cannot follow the demand. A method to fill out the gap is to make incentives to invest in alternative energy sources. One of the solutions for these issues is to introduce renewable energy, such as photovoltaic, wind energy.

Today the contribution from photovoltaic (PV) energy compared to the other renewable energy sources is very low, but due to decreasing system prices the market for PV systems is one of the most stable and fastest growing in the world. If this trend continues, PV will be one of the most important energy sources in the future. To maintain the further spread of PV systems it is important to decrease the cost and at the same time improve the efficiency and reliability of these systems. Valuable improvements can be made on the side of inverters for PV systems.. Therefore it seems to be a well spent effort to have a close look at the inverters, their topologies and control.

As the energy from the sun is free, the major cost of photovoltaic generation is the installation cost which is mainly composed of the costs of solar modules and the interface converter system, also called the power conditioning system (PCS). With the development of solar cell technology, the price of solar modules has dropped dramatically. A recent worldwide survey shows that in the last three years, the retail price of solar modules has dropped 16.95%. However, at the same time, the prices for the solar power system almost remain the same. To lower the cost of the PV system has become a very urgent issue of residential PV systems. Solar power system is required to convert the dc output from PV cell to 230v, 50Hz ac output for residential use in India.

This paper proposes a full bridge voltage source inverter based solar power system for residential use. By utilizing the full bridge voltage source inverter, the number of switching components and the total volume of the system can be minimized. Thus, the cost of the systems is minimized.

For safety reasons, most PV systems have a galvanic isolation, either in the DC-DC boost converter in the form of a high frequency transformer, or on the AC output side, in the form of a bulky low frequency transformer. Both of these added galvanic isolations increase the cost and size of the whole system and decrease the overall efficiency.

A higher efficiency, smaller size & weight and a lower price for the inverter is possible in the case where the isolation transformer is omitted.

Recently, transformer-less inverters have been proposed to reduce sizes and costs of photovoltaic power systems. However, in such conventional inverters, there is an inevitable potential difference between the PV array and the ground level of utility grid line. Then it causes the earth-leakage current and rises some serious problem in the system.

This paper presents a transformer-less single phase inverter for a PV power system which is applied for the home usage. The output power of proposed inverter is under 288W. The inverter consists of two sets of Boost type chopper circuit, and the number of switching devices which are used in the system is less than that in the conventional system. A transformer and an inductor which links to a utility grid line are not necessary for the system. In the system, there is no earth-leakage current at all in the theoretical base. In this paper, simulated and experimental results are shown using the prototype systems whose power is 37W.

There are two main topology groups used in case of grid connected PV systems and they are: with and without galvanic isolation. Galvanic isolation can be on the DC side, in the form of a high frequency DC-DC transformer or on the grid side in the form of a big-bulky AC transformer. Both of these solutions offer the safety and advantage of galvanic isolation, but the efficiency of the whole system is decreased, due to power losses in these extra components. In case the transformer is omitted the efficiency of the whole PV system can be increased with an extra 1-2%. The most important advantages of transformerless PV systems can be observed in Fig. 1, like: higher efficiency, smaller size and weight compared to the PV systems that have galvanic isolation (either on the DC or AC side).

Fig. 1 has been made from the database of more than 400 commercially available PV inverters, presented in a commercial magazine about PV systems[14]. Transformerless inverters are represented by the dots (Transformerless), while the triangles represent the inverters that have a low-frequency transformer on the grid side (LF-transformer) and last the stars represent the topologies including a high-frequency DC-DC transformer (HF-transformer), adding a galvanic isolation between the PV and grid. The conclusion drawn from these graphs is that transformerless inverters have higher efficiency, smaller weight and size than their counterparts with galvanic separation.

Transformerless PV inverters use different solutions to minimize the leakage ground current and improve the efficiency of the whole system, an issue that has previously been treated in many papers.

In the past, various different inverter topologies have been suggested or are currently used for low power, single-phase grid-connected photovoltaic (PV) systems. A

common technology is a full-bridge inverter in combination with a line-frequency transformer. The transformer, however, is not a requirement and inverters without transformers offer several advantages. Table 1 shows the results of a comparison of single-phase inverters for grid-connected PV systems in the power range 1±2 kW. Thirty inverters were compared, of which seven were transformerless (23 with transformer) [15]. The figures for weight and price are normalised to the inverters' rated power and especially the price difference between the two inverter types is impressive (the transformerless type being nearly 25% cheaper).

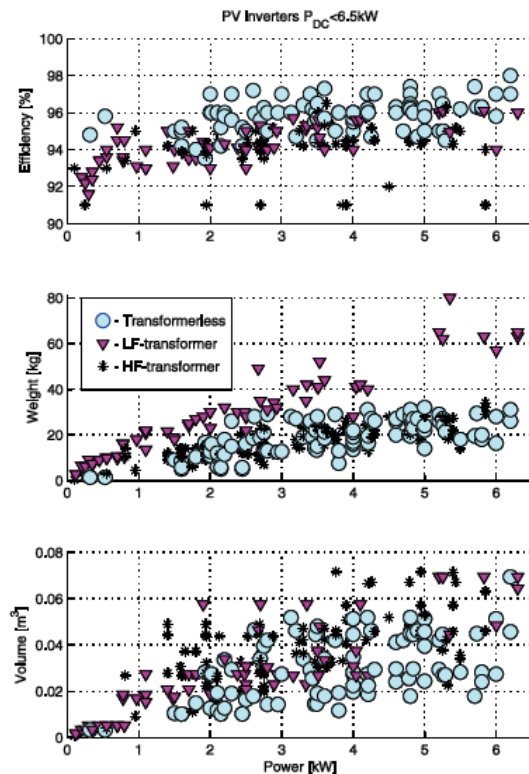

Fig.1 Advantages and drawback of different inverter topologies [14].

Photovoltaic (PV) systems provides a viable means of power generation for applications like powering residential appliances, electrification of villages in rural areas, telecommunications, refrigeration, water pumping (particularly in agricultural irrigation). Photovoltaic-power generation is reliable, involves no moving parts, and operation and maintenance costs are very low. These systems operate silently and create no atmospheric pollution. They can also provide important social and economic benefits to rural communities in the world where other types of electricity supply are unavailable. Their only major handicap is that they have a high capital cost. If the environmental and social costs of other conventional power generations are taken into account, this form of power generation can be considered cost effective. Therefore, the productive activities, especially for the sake of economic gain, should be emphasized in PV power systems to promote their use.

TABLE I

Comparison of 30 inverters(23 with transformer, 7 transformerless) for single phase, grid connected PV systems(1-2 KW) [15]

Inverter type	Max. Efficiency %	Weight Kg/KW	Price (Rs/W)
With Transformer	93.1	16.1	81.90
Transformerless	95.9	12.3	61.74

In photovoltaic power systems, other than solar modules, there are many parts required to provide a satisfactory electricity supply. Many of them contain a provision for energy storage to supply electricity at night and during periods of inclement weather. In order to interface the different parts of the system and to allow for the variable nature of the converted solar energy, other power-conditioning or control elements are needed. For lead-acid batteries, the charging regime may have a significant impact on the service life. In addition, for supplying AC loads in a PV power system, an inverter is a critical component, which converts the DC power of the module and the battery into AC, generally in the form of 50 Hz power. The converters are usually designed to produce high quality, low distortion AC power.

This paper introduces a microcontroller-based stand-alone PV system, which has a energy storage system and voltage source inverter. Because of the usefulness of a battery energy storage system, PV power is controlled by a dc-dc converter and transferred to a battery, which stabilizes DC voltage on the DC side of the voltage source inverter (VSI). The VSI provides a regulated sine-wave output current for residential loads and it is digitally controlled by Pulse Width Modulation (PWM) signals. The increase of conversion efficiency is targeted by use of PWM signals by reducing the number of pulses on the output waveform. Also, storing the previously calculated signals, which have different modulation index values in EEPROM data memories, makes it possible to use low-cost microcontrollers, instead of Digital Signal Processor (DSP) chips, which are expensive.

II. THE FUTURE ENERGY CHALLENGE

The Challenge sought to dramatically improve the design and reduce the cost of dc-ac inverters and interface systems for use in distributed generation systems with the goal of making these interface systems practical and cost effective. The objectives are to design elegant, manufacturable systems that would reduce the costs of commercial interface systems by at least 50% and, thereby, accelerate the deployment of distributed generation systems in homes and buildings.

III. SOLAR POWER SYSTEM FOR RESIDENTIAL USE

A. Basic Requirements

In order to transfer the energy from PV array into residential use the converter systems have to fulfill the following points:

a) To convert the D.C voltage to A.C voltage.

- b) To boost the voltage if the PV array voltage is less than the utility voltage.
- c) To insure maximum power utilization from the PV array.

Fig. 2 & Fig. 3 show the two most commonly used converter system configurations in practice. In the system shown in Fig.2 a transformer at line frequency is utilized to boost the voltage after the dc-ac inverter. Usually, a line frequency transformer is associated with huge size, loud acoustic noise, and high cost. In addition, the inverter has to be oversized to cope with the wide PV array voltage change[9]. The KVA rating of the inverter is doubled if the PV voltage varies at a 1: 2 range. So in order to eliminate the transformer and to minimize the required KVA rating of the inverter, in many applications, a high frequency dc-dc converter is used to boost the voltage to a constant value as shown in Fig. 3.

B. Traditional Converter

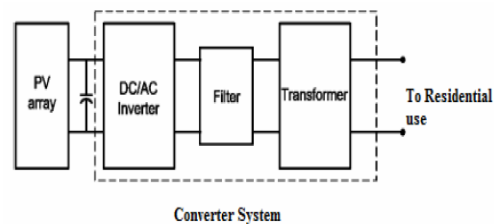

Fig.2 d.c to a.c with step up transformer in traditional PV system[9].

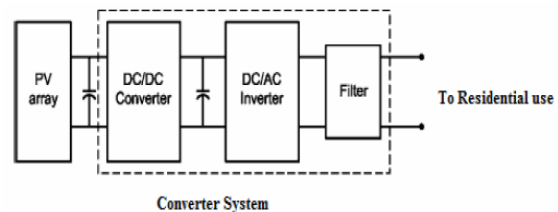

Fig.3 d.c to a.c with d.c – d.c boost in traditional PV system[9]

IV. PROPOSED INVERTER SYSTEM

In the proposed residential solar power system, a full bridge voltage-source inverter is utilized to realize inversion and boost function in two stages. Fig. 4 shows the proposed system. The inductors and capacitors are both energy storage devices, so their value can be optimally designed to ensure small size and low cost. The error between the reference and measured grid current is then fed to the current controller, which calculates the duty cycles for the next period. The new duty cycle is then forwarded to the PWM block, which calculates the gate signals comparing the duty cycles to a triangular carrier wave.

A. Full-Bridge VSI

Figure 5 shows the power topology of a full-bridge VSI. This inverter is similar to the half-bridge inverter; however, a second leg provides the neutral point to the load. As expected, both switches S1+ and S1- (or S2+ and S2-) cannot be on simultaneously because a short circuit

across the dc link voltage source v_i would be produced. There are four defined (states 1, 2, 3, and 4) and one undefined (state 5) switch states as shown in Table 2.

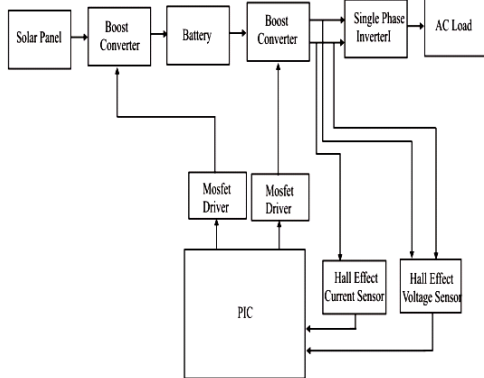

Fig.4 Block Diagram of the control strategy

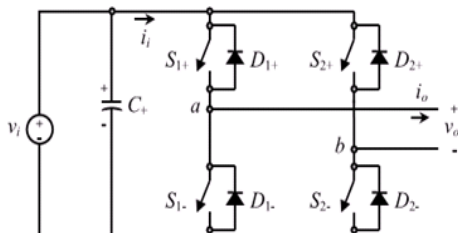

Fig. 5 Single-phase full-bridge VSI.

The undefined condition should be avoided so as to be always capable of defining the ac output voltage. In order to avoid the short circuit across the dc bus and the undefined ac output voltage condition, the modulating technique should ensure that either the top or the bottom switch of each leg is on at any instant. It can be observed that the ac output voltage can take values up to the dc link value v_i , which is twice that obtained with half-bridge VSI topologies. Several modulating techniques have been developed that are applicable to full-bridge VSIs. Among them are the PWM (bipolar and unipolar) techniques.

TABLE II.

Switch states for a full-bridge single-phase VSI

State	State#	V_0	Components Conducting
S_{1+} and S_{2-} are on and S_{1-} and S_{2+} are off	1	V_i	S_{1+} and S_{2-} if $i_a > 0$ D_{1-} and D_{2+} if $i_a < 0$
S_{1-} and S_{2+} are on and S_{1+} and S_{2-} are off	2	$-V_i$	D_{1+} and D_{2-} if $i_a > 0$ S_{1-} and S_{2+} if $i_a < 0$
S_{1+} and S_{2+} are on and S_{1-} and S_{2-} are off	3	0	S_{1+} and D_{2+} if $i_a > 0$ D_{1-} and S_{2-} if $i_a < 0$
S_{1-} and S_{2-} are on and S_{1+} and S_{2+} are off	4	0	D_{1+} and S_{2+} if $i_a > 0$ S_{1-} and D_{2-} if $i_a < 0$
S_{1-} , S_{2-} , S_{1+} and S_{2+} are all off	5	$-V_i$ V_i	D_{1-} and D_{2+} if $i_a > 0$ D_{1+} and D_{2-} if $i_a < 0$

Inverter Topologies

Type I: Inverters with a 50 Hz transformer: simple topology, high reliability, high volume and weight, maximum efficiency of 95%;

Type II: Inverters with a high frequency transformer: costly concept, low volume and weight, maximum efficiency of 91%;

Type III: Transformerless inverter: low weight, voltage transfer ratio up to 1:3, maximum efficiency of 95%;

I. Boost Operation Mode:

If the energy generated at the MPP is not enough to supply the load, the power system operates as a boost converter, transferring energy from the battery to the load. In this case, when the switch S is in the on state, the current in the boost inductor increases linearly and the diode D is off at that time. When the switch S is turned off, the energy stored in the inductor is released through the diode to the output RC circuit.

Using Faraday's law for the boost inductor

$$V_s DT = (V_o - V_s)(1 - D)T$$

As the name of the converter suggests, the output voltage s always greater than the input voltage.

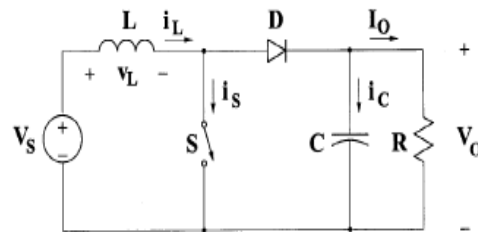

Fig. 6 Boost converter

The boost converter operates in the CCM for $L > L_b$ where

$$L_b = \frac{(1 - D)^2 DR}{2f}$$

For $D = 0.5$, $R = 1.54 \text{ Ohm}$, and $f = 20 \text{ kHz}$, the boundary value of the inductance is $L_b = 4.8185 \mu\text{H}$. The current supplied to the output RC circuit is discontinuous. Thus, a larger filter capacitor is required in comparison to that in the buck-derived converters to limit the output voltage ripple. The filter capacitor must provide the output dc current to the load when the diode D is off. The minimum value of the filter capacitance that results in the voltage ripple ΔV_0 is given by

$$C_{\min} = \frac{(I_{c,rms} * D T)}{\Delta V_0}$$

At $D = 0.5$, $\Delta V_0 = V_0 \cdot 1\%$, and $f = 20 \text{ kHz}$, the minimum capacitance for the boost converter is $C_{\min} = 625 \mu\text{F}$. The boost converter does not have a popular transformer (isolated) version.

The PIC16f877A microcontroller with driver circuit controls the output voltage of the boost circuit.

V. EXPERIMENTAL RESULTS

In order to verify the simulation results, an experimental setup has been done. The experimental setup is shown in figure 7.



Fig.7. Experimental set up

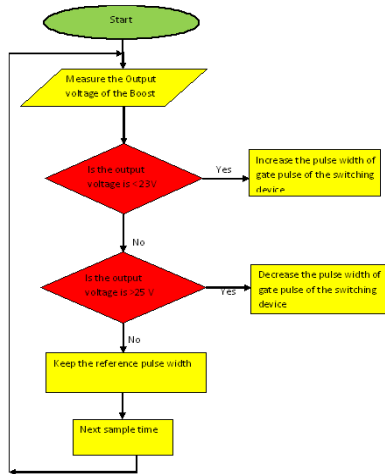

Fig. 8. Flow chart for programming the Boost control algorithm

VI. SIMULATION RESULT

The simulations were done in MATLAB Simulink using a fixed-sample solver, with a step size of $T_s=1e-7$. The switching frequency was set to $f_{sw}=20$ kHz. In order to simplify the simulation, the PV array was simulated with a DC voltage source and $V_{dc}=12V$. The Duty cycle of the first boost converter is 0.5 and that of the second converter is 0.68. The output filter $L_f=6mH$ filter inductance; $C_f=100 \mu F$ filter capacitance; the grid was modelled as a $f_g=50Hz$ grid with $V_g=75V_{rms}$. The simulation period was 1s.

The simulation setup with the following parameters:
 $L1 = L2 = 12\mu H$. and $C1 = C2 = 1,000 \mu F$
 The switching frequency = 20 KHz.
 The filter parameters are: $L = 6mH$, $C = 100\mu F$.

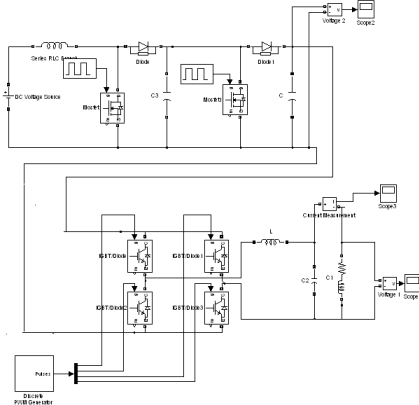

Fig.9. Simulink model of the system

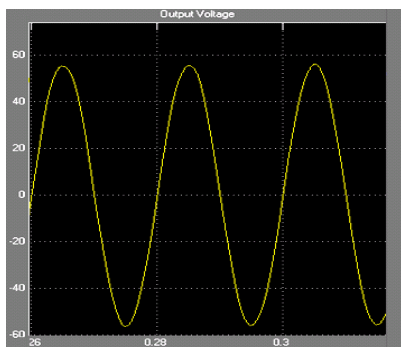

Fig. 10. Output voltage

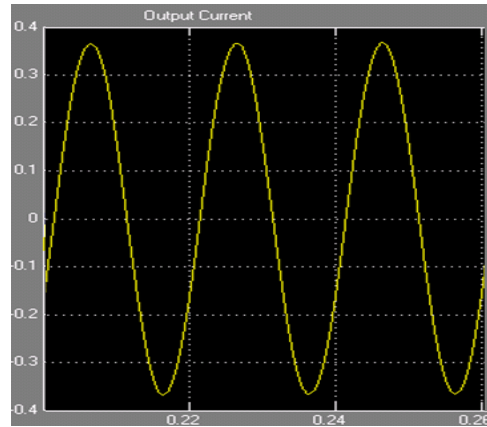

Fig.11. Output Current

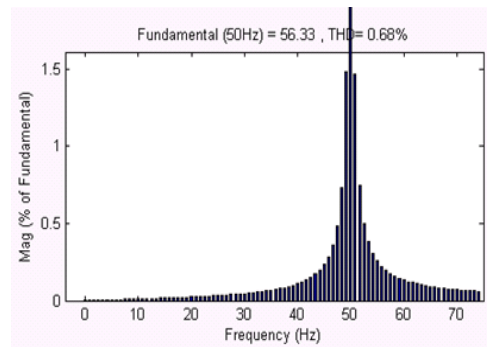

Fig. 12. Harmonic spectrum of output voltage after filter with constant dc voltage source

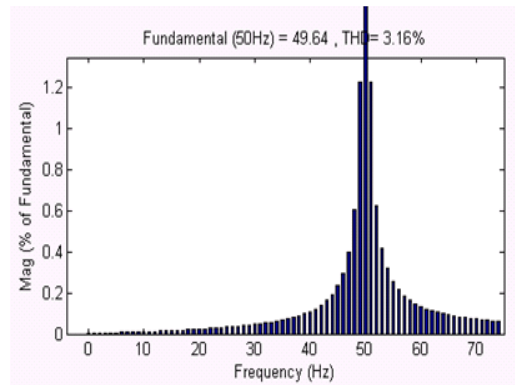

Fig. 13. Harmonic spectrum of output voltage before filter with constant dc voltage source

VII. CONCLUSION

In this paper, the implementation of a microcontroller-based stand-alone PV power system is presented. The PIC16F877A microcontrollers have been employed to implement the control scheme for the complete stand-alone PV power-system. One of the advantages of this system is reducing THD of output voltage to less than 1%. Transformerless inverters offer a better efficiency, compared to those inverters that have a galvanic isolation. On the other hand, in case the transformer is omitted, the generated common-mode behavior of the inverter topology greatly influences the ground leakage current through the parasitic capacitance of the PV. As a conclusion, the proposed topology can be an advantageous power-conversion stage for transformerless, grid-connected PV systems.

REFERENCES

- [1] M. Calais and V. G. Agelidis, "Multilevel converters for single-phase grid connected photovoltaic systems—An overview," in Proc. IEEE Int. Symp. Ind. Electron. 1998, vol. 1, pp. 224–229.
- [2] M. Calais, J. M. A. Myrzik, and V. G. Agelidis, "Inverters for single phase grid connected photovoltaic systems—Overview," in Proc. 17th Eur. Photovoltaic Solar Energy Conf., Munich, Germany, Oct. 22–26, 2001, pp. 1995–2000.
- [3] J. M. A. Myrzik and M. Calais, "String and module integrated inverters for single-phase grid connected photovoltaic systems—A review," in Proc. IEEE Power Tech. Conf., Bologna, Italy, Jun. 23–26, 2003, vol. 2, pp. 1–8.
- [4] IEEE Standard for Interconnecting Distributed Resources with Electric Power Systems, IEEE Std. 1547, 2003.
- [5] S. B. Kjaer, J. K. Pedersen, and F. Blaabjerg, "A review of single-phase grid-connected inverters for photovoltaic modules," IEEE Trans. Ind. Appl., vol. 41, no. 5, pp. 1292–1306, Sep./Oct. 2005.
- [6] Y. Nishida, S. Nakamura, N. Aikawa, S. Sumiyoshi, H. Yamashita, and H. Omori, "A novel type of utility-interactive inverter for photovoltaic system," in Proc. 29th Annu. IEEE Ind. Electron. Soc. Conf., Nov. 2–6, 2003, vol. 3, pp. 2338–2343.
- [7] Y. Chen and K. M. Smedley, "A cost-effective single-stage inverter with maximum power point tracking," IEEE Trans. Power Electron., vol. 19, no. 5, pp. 1289–1294, Sep. 2004.
- [8] Roberto González, Eugenio Gubía, Jesús López, and Luis Marroyo, "Transformerless Single-Phase Multilevel-Based Photovoltaic Inverter," IEEE Transactions On Industrial Electronics, Vol. 55, No. 7, pp.2694 – 2702, July 2008.
- [9] Amitava Das, and Debasish Lahiri, "Transformerless Inverter for Residential Solar Energy System," TIG Research Journal, Vol. 1, No. 2, pp.86 – 95, September 2008.
- [10] Martina Calaisa, Vassilios G. Agelidisb, Michael S. Dymond, "A cascaded inverter for transformerless single-phase grid-connected photovoltaic systems," Renewable Energy 22 (2001), pp 255 – 262.
- [11] Roger Gules, Juliano De Pellegrin Pacheco, Hélio Leães Hey, and Johninon Imhoff, "A Maximum Power Point Tracking System With Parallel Connection for PV Stand-Alone Applications," IEEE Transactions On Industrial Electronics, Vol. 55, No. 7, pp 2674 – 2683, July 2008.
- [12] L. Nirupa Rathnayake, and T. Chandana Peiris, "Development of a Microcontroller Based Solar Smart Charge Controller for Solar Street Lamps," The 3rd International Conference on "Sustainable Energy and Environment (SEE 2009)," pp 573 – 578, 19-22 May 2009.
- [13] R. Akkaya, A. A. Kulaksiz, "A microcontroller-based stand-alone photovoltaic power system for residential appliances," Applied Energy 78 (2004) ,pp 419–431.
- [14] Photon International, The Photovoltaic Magazine, Apr.2007.
- [15] Welter P. Power up, prices down, grid connected inverter market survey (Leistung rauf, Preiserunter, MarkituEbersicht netzgekoppelter Wechselrichter, in German). PHOTON-das SolarstromMagazin (German Solar Electricity Magazine) 1999;3:48-57.

BIOGRAPHY



B. Bindu received the B.Tech. degree in Electrical and Electronics Engineering from N S S College of Engineering, Palakkad, in 1998, the M.E. degree in Energy Engineering from PSG College of Technology, Coimbatore, in 2010. Her research interests include Control Systems, Energy Management, and Measurement Technologies in CNC lathes. She has totally around 10 years of teaching experience.