

# Implementation of UWB-OFDM Fixed Point Model Using PAPR-Clipping Technique with Frequency Hopping Filtering Technique

M.Teja Kiran Kumar<sup>1</sup>, P.Dhana Lakshmi<sup>2</sup>

PG student, University College of Eng., and Technology, Acharya Nagarjuna University, Guntur, India<sup>1</sup>

Assistant Professor, University College of Eng., and Technology, Acharya Nagarjuna University, Guntur, India<sup>2</sup>

**Abstract:** In a communication system, operation of the transmitter power amplifier is limited to linear range. Input signal with an amplitude more than the transmitter power amplifier linear range results in signal distortion. Hence, the input signal to the transmitter should be with low peak to average power ratio. This paper presents a PAPR reduced UWB (ultra wide band) model using clipping Technique and Frequency Hopping Filtering. Due this model we evaluated the low PAPR, Increased signal efficiency and by low Bit error rate. Frequency hopping to decrease channel fading and Inter Symbol Interference.

**Index terms:** Convolution encoder, MB-OFDM system, UWB, Viterbi decoder.

## I. INTRODUCTION

OFDM is a multi carrier system .OFDM is preferred more in the communication system now a day due to Bandwidth efficiency, high data rate and immune to fading. Digital Audio Broadcasting (DAB), Digital Video Broadcasting (DVB), Wireless Local Area Network (WLAN) and Long Term Evolution (LTE) uses OFDM system as Transmitter and Receiver. OFDM has many advantages in Communication system but it suffers from many technical difficulties. Few of these difficulties include tight frequency synchronization, time offset, peak to average power ratio (PAPR) and channel estimation. The Technology of wireless communication devices in our lives shows no sign of Degradation. It is adopted in wireless communication due its Faster Stream and Quality of media with high data rates. Wireless Personal Area Network (WPAN) space have already met the demand for high data rates in communication network. Now a days the high data rated Wireless Personal Area Network (WPAN) standard is IEEE802.15.3 .A task group of IEEE802.15.3a is set out for employing high data rate alternate physical layer for IEEE802.15.3 and after all of the physicallayers currently employing ultra wideband(UWB) communications. The promising candidates for Physical layer of short-range high data-rate UWB communications is Multiband-OFDM

(MB-OFDM) [1]. It is a Orthogonal Frequency Division Multiplexing (OFDM) with the multi-banded approach enabling the UWB transmission to derive all the strength of OFDM technique in wireless communications (ADSL, DVB, 802.11, 802.16., etc.) which has already been proven. For above reasons the Physical layer technology for UWB communication which was proposed in MB-OFDM of IEEE802.15.3a standardization process for Wireless Personal Area Network (WPAN) communications.

## II. UWB-OFDM SYSTEM MODEL

Ultra-wideband (UWB) wireless personal area network technology may also utilize OFDM, such as in Multiband OFDM (MB-OFDM). A multi-band OFDM system [2] divides the available bandwidth into smaller non-overlapping sub-bands. The Federal Communications Commission (FCC) also specified that a UWB signal must occupy a minimum 10-dB bandwidth of 500 MHz. In many ways, this portion of the ruling has revolutionized the design of UWB communication systems. Instead of having to use the entire band to transmit information, the spectrum can now be divided into several sub-bands, whose bandwidth is approximately 500 MHz. By interleaving the symbols across sub-bands, UWB systems can still maintain the same transmit power as if they were using the entire bandwidth. The symbols of OFDM will sent through one of the sub-bands in a particular time slot. The sub-band selection at each time-slot is determined by a Time-Frequency Code (TFC). The TFC is used to provide frequency diversity in the system and also to distinguish between multiple users.

The proposed UWB system [3] Band is formed by Five sub-bands in which first four sub-bands are divided in to three frequency bands and these frequency bands are called as band groups. Fifth sub-band is divided in to two frequency bands are defined in the UWB spectrum mask (figure 1). Not all bands are permitted by the world-wide regulatory bodies. Particular attention has been given to BG#1 which may only be utilised in Europe for a limited time, except for utilising band #3 with detect-and-avoid are utilised to ensure no interference is caused to the Primary User. Furthermore, most manufacturers and regulators seem to agree not to utilise BG#2 due to the high density of wireless services in that spectral band. Figure 2 shows a TFC, where the available bandwidth

from 3.168- 4.752 GHz i.e.,1.584GHz is divided into three sub-bands of 528MHz each.

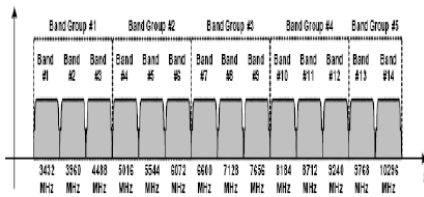

Figure 1: UWB Spectrum Division into Band Groups and sub-bands

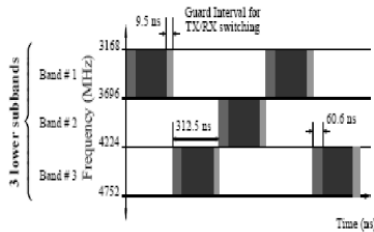

Figure 2: Example of Time-Frequency Code in MB-OFDM system

Figure 3 shown is a MB-OFDM UWB [4] model designed in Simulink which illustrates the transmitter and receiver of the MB-OFDM UWB system. This consists of two parts baseband and Radio Frequency (RF). In this transmitter the basebandof which consists of Convolution Encoder. Here encoder adds patterns of redundancy to the data in order to improve the SNR for more accurate decoding of the receiver. The system supports five different coding rates 1/3, 11/32,1/2,5/8, and 3/4in this proposed model we used 5/8 coding rate.

The Interleaver block is to provide robustness against burst errors [3]. The bit interleaving operates in the two stages i.e. Symbol Interleaving followed by a Tone Interleaving. The OFDM subcarriers are modulated using QPSK modulation. An input Binary Sequence is now converted in to Complex Valued Sequence according to Gray-Coded Constellation mapping.

The sequence in series are now converted in to parallel, Sequences before IFFT block the sequences are inserted with the Pilots,Guards and Nulls. These sequences are said to be OFDM symbols. Now each of these symbols contain 128 subcarriers. The duration for an OFDM symbol is  $T_S = 242.42$  nsec. Now the cyclic prefix is used to eliminate the ISI in the OFDM symbol and for the smooth transition between two adjacent OFDM symbols Guard Interval is appended. The duration of the cyclic prefix for the 32 subcarriers is  $T_C = 60.61$  nsec. The duration of the guard interval is  $T_G = 9.47$  nsec for

Table 1. UWB System Parameters

PAPR in OFDM signal by setting to certainthe 5 subcarriers. Now before RF implementation PAPR reduction block with Amplitude clipping is taken to reduce PAPR in OFDM signal by setting to certain Threshold level. After this in RF Implementation on the signal is up sampled and transmitted through the UWB antenna. The receiver side of proposed model, consists of similar blocks in the transmitter but in the reverse order. The system parameters for MB-OFDM UWB system are listed in table 1

Parameter	Values
Total bandwidth	528 MHz
NSD: Number of data subcarriers	100
NSDP: Number of defined pilot carriers	12
NSUP: Number of undefined pilot carriers	10
NST: Number of total subcarriers used	122(=NSD+NSDP+NSUP)
Subcarrier frequency spacing	4.125MHz(528MHz/128)
TFFT: IFFT/FFT period	242.42ns (=128/528MHz)
TCP: Cyclic prefix duration	60.61ns(=32/528MHz)
TGI: Guard interval duration	9.47ns(=5/528MHz)
TSYM: Symbol interval parameter	312.5ns(TCP+TFFT+TGI)v alue
Data rates	53.3,55,80,106.7,110,160,200,320,400,480Mbits/s

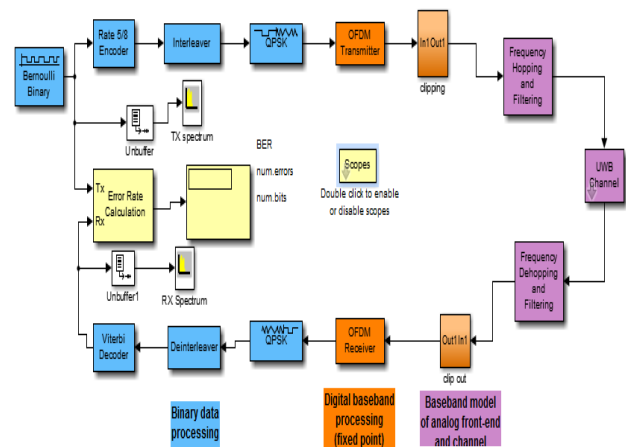

Figure3:MB-OFDM UWB Model Designed In Simulink

### III. UWB CHANNEL MODEL

The modified Saleh-Valenzuela (S-V) model[5]-[6]-[7] was adopted as a reference UWB channel model by the IEEE 802.15.3. The modelling of UWB channels is based on the measurement of indoor propagation environment, the main commercial application of UWB model is for Indoor communication. The extremely multipath-rich profile and non-Rayleigh fading amplitude characteristics are the main distinguishing features of UWB propagationchannel. The modelling of UWB propagation channel is fully based on the proposed IEEE 802.15.3a Standard Model. The S-V multipath model is given by equation 1

$$h_l(t) = \sum_{k=0}^{K-1} \alpha_{k,l} \delta(t - T_l - \tau_{k,l}) \dots (1)$$

where ,

L = number of clusters;

K = number of multipath components (number of rays) in the lth cluster;

$\alpha_{k,l}$  = Multipath gain coefficient of kth ray in lth cluster;

$T_l$  = arrival time of the first ray of the lth cluster, ,

$\tau_{k,l}$  = delay of the kth ray within the lth cluster relative to the first path arrival time,  $T_l$ ;

#### IV. PAPR REDUCTION IN PROPOSED MODEL

OFDM has its major benefits of higher data rates and better performance. High data rates are achieved by the use of multiple carriers and performance improvement is caused by the use of guard interval thus mitigating ISI. Apart from these basic benefits, it also increases spectral efficiency, minimizes multipath distortion and many more. Keeping in view these benefits, it has a really nice market penetration and one of the most useful technologies is WLAN and OFDM is used in IEEE 802.11a/g/n architectures quite successfully .Although the use of multiple carriers is quite handy, it is accompanied by a lot of implementation problems like major one being the high Peak to Average Power Ratio (PAPR) of OFDM systems

$$PAPR[\bar{x}] = \frac{\max |x(t)|^2}{E[|x(t)|^2]} \dots \dots \dots (4)$$

Where  $x(t)$  denotes the pass band signal whose PAPR is to be calculated.

Here we simulated and compared three papr reduction Techniques namely SLM(selected mapping),PTS(Partial Transmit Sequence) and Amplitude Clipping Technique are shown in the tabular form for comparison given below.

Parameters	PAPR) Reduction Techniques		
	Amplitude Clipping & filtering	Selected mapping	Partial Transmit sequence
Implementation complexity	LOW	LOW	High
BW reduction	Yes	No	YES
Distortionless	No	Yes	Yes
Data Loss	No	Yes	Yes
Power increases	No	No	No
Requires processing at Tx or Rx	Tx: Amplitude clipping, Filtering Rx: None	Tx- UIFFT Rx: Side information extraction, inverse interleaving	peak reduction sub carriers are assigned to each user in the TR for PAPR reduction
Reduced data rate	No	Yes	Yes
Boosted BER	No	Yes	Yes

Table 2: Comparison of PAPR reduction Techniques

In order to reduce PAPR we used the Amplitude Clipping Techniques simulation. Which is shown in simulations and results .In order to select best technique for the proposed model.



Figure 4: Amplitude Clipping Block Diagram

#### V. FREQUENCY HOPPING AND FILTERING IN PROPOSED MODEL

In frequency hopping systems, the transmitter changes the Carrier frequency according to a certain "hopping" pattern. The advantage is that the signal sees a different channel and a different set of interfering signals during each hop. This avoids

the problem of failing communication at a particular frequency, because of a fade or a particular interferer.

There are two kinds of frequency hopping

- **Slow Frequency Hopping (SFH)**  
 In this case one or more data bits are transmitted within one hop. An advantage is that coherent data detection is possible. Often, systems using slow hopping also employ (burst) error control coding to restore loss of (multiple) bits in one hop.
- **Fast Frequency Hopping (FFH)**  
 One data bit is divided over multiple hops. In fast hopping, coherent signal detection is difficult, and seldom used. Mostly, FSK or MFSK modulation is used.

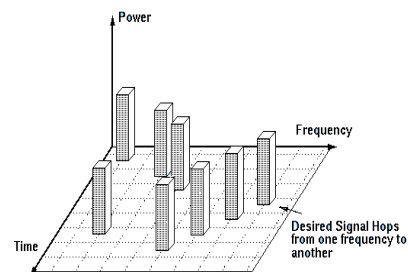

Figure 5. Frequency Hopping of Signal

Slow frequency hopping is a popular technique for wireless LANs. In GSM telephony; slow frequency hopping can be used, at the discretion of the network control software. It avoids that a stationary terminal that happens to be located in a fade loses in its link to the base station. Slow frequency hopping is used in the proposed model due its advantages stated above than fast frequency hopping

#### VI. SIMULATION AND RESULTS

Complementary Cumulative Distribution Function (CCDF) of the proposed method is carried out by simulation. In this simulation QPSK modulation were used. 512 number of sub-carriers were incorporated for data

transmission. Fig. 6 is OFDM Spectrum and Fig. 7 is the PAPR performance

Comparison of the proposed OFDM using QPSK modulation

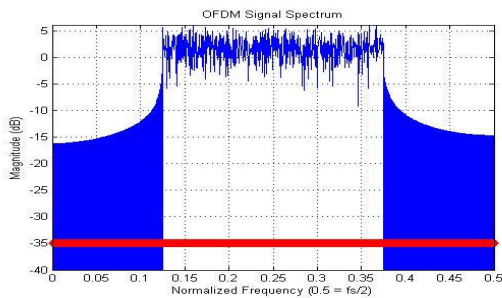

Figure 6. OFDM Signal Spectrum

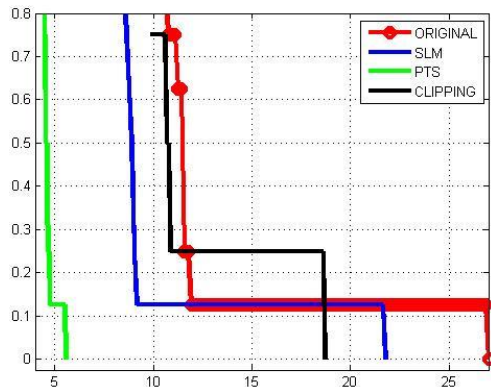

Figure 7. Papr Comparison of OFDM

As OFDM symbols are transmitted using one of the sub-bands in a particular time-slot. The sub-band selection at each time-slot is determined by a TFC. Here the simulation results are carried out for TFC 1 in the band group1 which is mandatory (figure 8). The band is split into 3 sub-bands each with bandwidth of 528MHz, and in the spectrogram plot. One can see how the time-frequency interleaving is achieved by only using one of the 528MHz sub-bands at a time. In the spectrogram, the x-axis represents time, the y-axis represents frequency, and the color indicates the power of the signal at that particular time and frequency with the red colors indicating high power, and blue colors indicating low power.

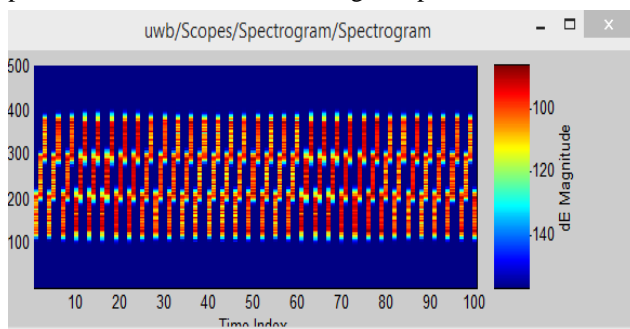

Figure 8: Spectrogram

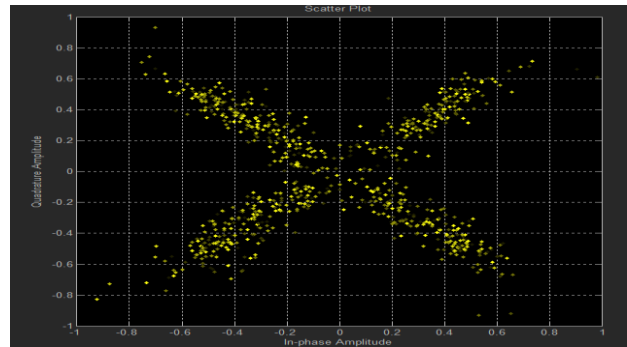

Figure 9: The signal constellation

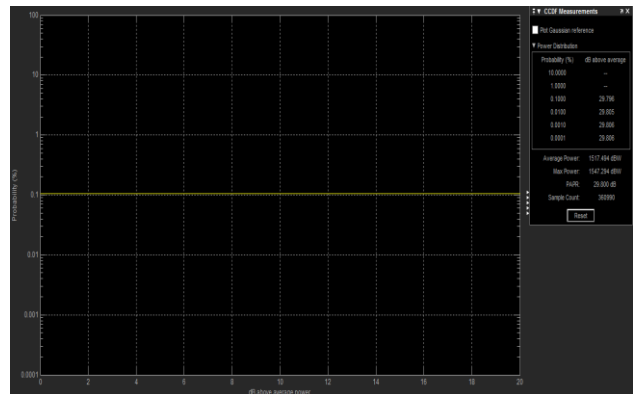

Figure 10. TX of above model with PAPR=29.800dB (Without any Techniques)

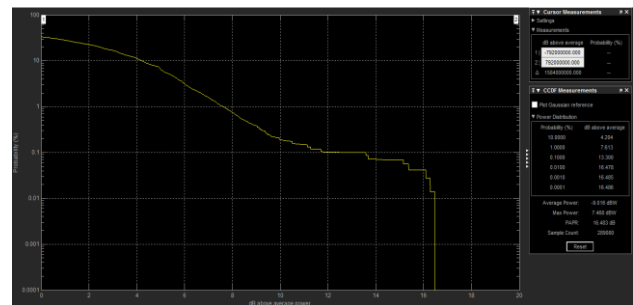

Figure 11. TX of above model with frequency hopping and filtering gives PAPR=16.483dB

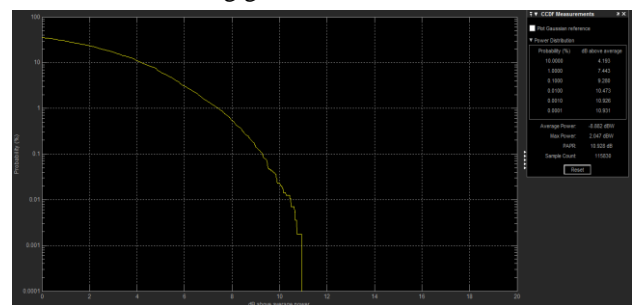

Figure 12. TX of uwB OFDM model with Frequency Hopping and Amplitude Clipping Technique gives PAPR=10.928dB.

From the figures 10,11,12 we observe decreased papr and with increased performance.

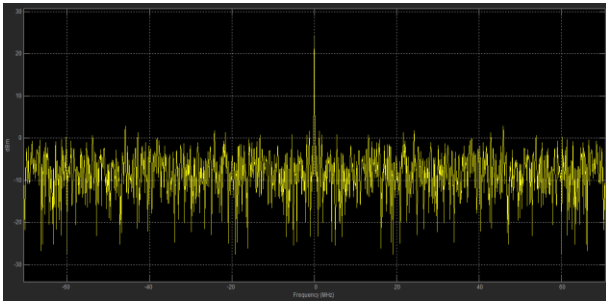

Figure13.Above Shown is the Transmitted Signal

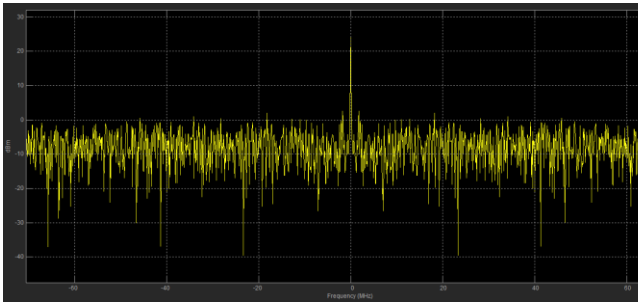

Figure14.Above figure shows Received signal

0.03086	BER
1804	num.errors
5.847e+04	num.bits

Figure15.Shows Comparison of TX and RX.From the above results we find BER is low,less errors and we also find PAPR is Low for the Proposed Method.

## VII. CONCLUSION

The work in this paper includes the baseband implementation and performance analysis of the MB-OFDM UWB system with the solved serious problem of PAPR. Since UWB transmission technology is the future technology which promises to fulfill the demand of high transmission data rates without any Intersymbol Interference, Now understanding the architecture and the performance of the UWB system is important. The implementation and the performance analysis help us to achieve High data rates. The high data rates are consistent with the increasing need to synchronize and stream the ever-increasing amounts of media, video and other forms of data present in the everyday lives of ordinary people. The baseband implementation of the MB-OFDM UWB system follows the standard proposal IEEE 802.15.3a in a straight forward manner. We analyzed the system performance according to IEEE 802.15.3a channel standard.In this paper, UWB fixed-point simulation platform for MB-OFDM system is constructed, and PAPR is reduced based on this platform, the performance degradation of fixed for digital baseband receiver and Viterbi decoder is analyzed. The result of simulation show that for fixed-point realization, receiver's digital baseband and viterbi decoder use 12 bit can fulfill the requirement. Through the implementation and the performance analysis, we have obtained a good understanding about the architecture and the performance of the MB-OFDM UWB system. The understanding would help us improving the

system in the future.The future scope of the project is to implement WiMedia and Wireless USB have published specifications and authorised networks of certification laboratories. In addition, the technology has room to grow with the higher data rates and energy-saving improvements defined in WiMedia 1.5

## REFERENCES

- [1] A. Batra, J. Balakrishnan and A. Dabak, "Multi-band OFDM: a new approach for UWB", *Internat.Symp. on Circuits Systems*, May 2004.
- [2] A. Batra, J. Balakrishnan, A. Dabak and et al., "Multi-Band-OFDM Physical Layer Proposal for IEEE 802.15 Task Group 3a", *IEEE P802.15-03/268r3*, March 2004.
- [3] S. Sadough, A. Mahmood I, E. Jaffrot, Pierre Duhamel," Performance Evaluation of MB-OFDM based UWB System", *Journal of Iranian Association of Electrical and Electronics Engineers - Vol.4- No.1- Spring and summer 2007*.
- [4] A. Batra, J. Balakrishnan and A. Dabak, "Multi-band OFDM: a new approach for UWB", *Internat.Symp. on Circuits Systems*, May 2004.
- [5] A. Saleh and R. Valenzuela, "A Statistical Model for Indoor Multipath Propagation", *IEEE JSAC*, Vol. SAC-5, pp. 128-137, Feb. 1987.
- [6] A. Batra, J. Balakrishnan, G. R. Aiello, J. R. Foerster and A. Dabak, "Design of a Multi-Band OFDM system for realistic UWB channel environments", *IEEE Transactions on Microwave Theory and Techniques*, Vol. 52, Issue 9, pp. 2123-2138, 2004.
- [7] Ch. Sasmita Das, Bikramaditya Das, Susmita Das, Member, IEEE," Efficacy of Multiband OFDM Approach in High Data Rate Ultra WideBand WPAN Physical Layer Standard using Realistic Channel Models", *International Journal of Computer Applications (0975 – 8887) Volume 2 – No.2, May 2010*

## BIOGRAPHIES

**Mr. M.Teja Kiran Kumar**, He is an PG Student in University College Of Engineering and Technology, Acharya Nagarjuna University, Guntur, India. He completed his B.Tech degree in Vignans Institute Of Information Technology, Visakhapatnam, India. His interesting fields are Telecommunications and digital communications.

**Mrs. P.Dhana Lakshmi**, M.Tech, She completed her studies at bapatla engineering and technology, bapatla, India. she works as an Assistant Professor in University College Of Engineering and Technology, Acharya Nagarjuna University, Guntur, India. Her interesting fields are Wireless Communications and Signal Processing.